



Poétic

garden
Saison 22



planters
garden
life
& indoor
& outdoor
French
made



POÉTIC 2022 WELCOME

Poétic
Oom
Ovw recycling
joy of life 2022
nature
C'est le jardin



H

o

m

e

h

e

find
it

ABOUT US	6
RECYCLING	8
NOVELTIES	10

01 MODERN

New ELEMENT	14
New GAÏA	20
MATERIAL	24
CASA MESH	26
CASA BRILLIANT	30
CASA MAT	31
CASA COSY	32
New CASA AUTHENTIC	34
CASA SLEEVE	36
ORIGINE	38

02 EASY

New JOY	42
ROMÉO	50
ROMÉO XXL	67
PAPYRUS	68
LILO	70
New LUNE	72
LANDHAUS	74
LANDHAUS BIRDWORLD	80
FRESH HERBS	84

03 BASIC

New MY CITY GARDEN	88
AROMABRIK	98
SCALA	100
FLORIO	102
COSTA	104
TERRA GRANDE	108
LOTUS	110
SIENA NOBILE	112
AQUARELLE	114
ODÉLIA	115
LAGO	116

04 FLOWER CARE

New HANA	120
LOFT	122
FUCHSIA	124
OASE	128
New EMMA	129
New XL WATERING CANS	130

05 ACCESSORIES

BUCKETS	134
SAUCERS	135
GARDEN CONTAINERS	136
VARIOUS	137
SUPPORTS	138
SPARE PARTS	146
ESTERAS	148
COLOURS	150
PRODUCT DETAILS	150
CONTACTS	151





made in
france



bonjour.



Poétic – French touch for your world of garden. Successfully established in France, we have been producing planters and garden accessories for 77 years. Enthusiastic and inspired by nature, we are constantly looking for new products and international trends. Our product range is easy to use and decorative with a touch of French flair!

Poétic – La french touch s'invite dans votre jardin ! 100% français depuis 77 ans, nous produisons des jardinières et des accessoires de jardin. Enthousiastes et inspirés par la nature nous cherchons constamment à créer de nouveaux produits à la fois facilitants et décoratifs. Guidées par les tendances internationales de couleurs et de formes, nos équipes recherchent l'esthétisme, pour une touche d'art de vivre à la française.

Poétic – Französischer Flair für Ihre Gartenwelt. Erfolgreich etabliert in Frankreich, produzieren wir Pflanzgefäße und Gartenaccessoires seit 77 Jahren. Begeistert und inspiriert von der Natur – so charakterisiert sich unsere stetige Suche nach neuen Produkten und internationalen Trends. Unser Sortiment ist einfach in der Anwendung und dekorativ, mit einem Hauch von französischem Flair!

FOLLOW US



100% recycled plastic

Preparing a world of tomorrow that is more respectful of the environment – this is Poétic’s commitment and mission! We work every day to find innovative solutions for a sustainable assortment and aim at using 100% recycled and recyclable materials for the production of our products. By using recyclable, precious plastic resources from everyday life, we are creating a circular economy. We have chosen to stop the so-called “throw-away-mentality”, becoming part of a more responsible cycle of consumption.

Préparer un monde de demain plus respectueux de l’environnement – c’est l’engagement pris par Poétic ! Nous travaillons tous les jours pour trouver des solutions et proposer l’ensemble de nos gammes en matière 100% recyclée et recyclable. En utilisant les déchets quotidiens des consommateurs, nous créons ainsi une économie circulaire : Poétic a choisi de rompre le modèle économique qui consiste à fabriquer, consommer et jeter, pour s’inscrire dans un cycle de consommation plus vertueux.

Gemeinsam für die grüne Welt von morgen – so lauten Engagement und Mission von Poétic! Wir arbeiten täglich an innovativen Lösungen für ein nachhaltiges Sortiment. Unser Ziel ist es, 100% recycelte und recycelbare Materialien für die Herstellung unserer Produkte zu verwenden. Indem wir wiederverwertbare, kostbare Kunststoffressourcen aus dem Alltag nutzen, erschaffen wir eine Kreislaufwirtschaft. Wir lehnen die „Wegwerf-Mentalität“ ab und sind somit Teil eines verantwortungsvollen Konsumzyklus.



**MADE
OF
RECYCLED
PLASTIC**

As the materials come from different recycling batches, there may be small colour variations.
Les matières étant issues de différents lots de recyclage, elles peuvent expliquer de légers écarts de teinte.
Da die Materialien verschiedenen Recyclingchargen entstammen, sind minimale Farbabweichungen möglich.

INNOVAT



New
SERIES

joy

JOY – our new, attractive series of colourful planters brings joy to your home and garden. All items within our new product range are made of 100% recycled plastic.

JOY – notre nouvelle gamme attractive de contenants haute en couleurs apporte de la joie à la maison et au jardin. Poëtic réussit son pari de mettre en valeur la matière plastique 100% recyclée.

JOY – unsere neue, attraktive Serie an farbenfrohen Pflanzgefäßen bringt Freude in Haus und Garten. Alle Artikel aus unserer neuen Produktfamilie werden aus 100% recyceltem Kunststoff hergestellt.

42



IONS



New
structure

22

gaïa

Discover our new decorative texture in zebra look – the eye-catcher for your home and the perfect addition to the GAÏA range.

Découvrez notre nouvelle texture décorative au look zébré – le complément parfait de la gamme GAÏA pour attirer l'attention dans votre maison.

Entdecken Sie unsere neue, dekorative Struktur im Zebra-Look – der Hingucker für Ihre Wohnung und die perfekte Ergänzung im GAÏA-Sortiment.

new
colours



The new sprayer with an eye-catching, stylish look! HANA combines a modern design and high quality.

Le nouveau vapo qui a du style ! HANA allie design moderne et finition haute qualité.

Der neue Sprüher im auffälligen, stylischen Look! HANA kombiniert ein modernes Design und eine exzellente Verarbeitung.

121

New
product



hana

- ELEMENT in white P./S. 15
- CASA Authentic in slate P./S. 35
- LUNE in khaki & blue jean P./S. 73
- MY CITY GARDEN in taupe P./S. 89
- EMMA in blue jean & sunflower P./S. 129
- XL WATERING CAN in blue jean & sunflower P./S. 131





modern in living space

A series of planters dedicated to indoor and outdoor green decoration. Contemporary, clean lines combined with unique textural effects. The assurance of quality products to take care of your most beautiful plants for a long time.

Une série de contenants dédiée à la décoration végétale en intérieur et extérieur. Des lignes contemporaines et épurées, associées à des effets de texture unique. L'assurance de produits de qualité pour prendre soin de ses plus belles plantes, longtemps.

Eine Serie von Pflanzgefäßen für die Dekoration im Indoor- und Outdoorbereich. Zeitgemäße, klare Linien kombiniert mit einzigartigen Struktureffekten. Hochwertige Produkte für die professionelle und beständige Pflege Ihrer Pflanzen.

01 MODERN ELEMENT

A beautiful finish, elegant lines, natural colours... The ELEMENT range has a lot to offer for outdoor decoration and is made of recycled material (post-consumer), thus being environmentally friendly.

Une jolie finition, des lignes élégantes, des couleurs naturelles... La gamme ELEMENT ne manque pas d'atouts pour décorer les extérieurs. Fabriquée à partir de matière recyclée post-consommation, ces contenants participent au respect de l'environnement.

Eine schön strukturierte Oberfläche, elegante Linien, natürliche Farben, robuste und hochwertige Wände... Die Serie ELEMENT ist hergestellt aus recyceltem Material (Post-Consumer) und bietet Ihnen alles für eine moderne Dekoration Ihrer Terrassen und Balkone.



















high quality
5
YEARS
GUARANTEE

element





ROUND PLANTER

POT ROND / BLUMENKÜBEL RUND

COLOUR	Ø×H	••L	C-CODE	EAN	
 slate	39,3×32	26,2	PELPRD40AR	 3 167890 003041	6
	48,3×38,4	47,8	PELPRD50AR	 3 167890 003096	4
 graphite	39,3×32	26,2	PELPRD40GP	 3 167890 003010	6
	48,3×38,4	47,8	PELPRD50GP	 3 167890 003065	4
 limestone	39,3×32	26,2	PELPRD40CAL	 3 167890 003034	6
	48,3×38,4	47,8	PELPRD50CAL	 3 167890 003089	4
 white	39,3×32	26,2	PELPRD40BL	 3 167890 036278	6
	48,3×38,4	47,8	PELPRD50BL	 3 167890 036283	4
 concrete	39,3×32	26,2	PELPRD40BT	 3 167890 003003	6
	48,3×38,4	47,8	PELPRD50BT	 3 167890 003058	4

New colour



















Ø×H	C-CODE	EAN	
25,1×1,6	SPEL25AR	 3 167890 001856	5
33,5×2,4	SPEL34AR	 3 167890 001900	6
25,1×1,6	SPEL25GP	 3 167890 001818	5
33,5×2,4	SPEL34GP	 3 167890 001870	6
25,1×1,6	SPEL25CAL	 3 167890 001849	5
33,5×2,4	SPEL34CAL	 3 167890 001894	6
25,1×1,6	SPEL25BL	 3 167890 036247	5
33,5×2,4	SPEL34BL	 3 167890 036261	6
25,1×1,6	SPEL25BT	 3 167890 001801	5
33,5×2,4	SPEL34BT	 3 167890 001863	6

EDGE PLANTER

POT ROND / BLUMENKÜBEL MIT RAND



COLOUR	Ø×H	••L	C-CODE	EAN	
 slate	29,1×28,4	12,4	PELPED30AR	 3 167890 002792	5
	38,2×36	27,7	PELPED40AR	 3 167890 002846	6
 graphite	29,1×28,4	12,4	PELPED30GP	 3 167890 002761	5
	38,2×36	27,7	PELPED40GP	 3 167890 002815	6
 limestone	29,1×28,4	12,4	PELPED30CAL	 3 167890 002785	5
	38,2×36	27,7	PELPED40CAL	 3 167890 002839	6
 white	29,1×28,4	12,4	PELPED30BL	 3 167890 036292	5
	38,2×36	27,7	PELPED40BL	 3 167890 036315	6
 concrete	29,1×28,4	12,4	PELPED30BT	 3 167890 002754	5
	38,2×36	27,7	PELPED40BT	 3 167890 002808	6

New colour



Ø×H	C-CODE	EAN	
25,1×1,6	SPEL25AR	 3 167890 001856	5
33,5×2,4	SPEL34AR	 3 167890 001900	6
25,1×1,6	SPEL25GP	 3 167890 001818	5
33,5×2,4	SPEL34GP	 3 167890 001870	6
25,1×1,6	SPEL25CAL	 3 167890 001849	5
33,5×2,4	SPEL34CAL	 3 167890 001894	6
25,1×1,6	SPEL25BL	 3 167890 036247	5
33,5×2,4	SPEL34BL	 3 167890 036261	6
25,1×1,6	SPEL25BT	 3 167890 001801	5
33,5×2,4	SPEL34BT	 3 167890 001863	6



CONICAL PLANTER

POT CONIQUE / BLUMENKÜBEL KONISCH



COLOUR	Ø×H	••• L	C-CODE	EAN	
● slate	25×24	8,7	PELPCO25AR	3 1 67890 002891	6
	39,1×32	30	PELPCO40AR	3 1 67890 002945	6
	49,3×42	62,2	PELPCO50AR	3 1 67890 002990	4
● graphite	25×24	8,7	PELPCO25GP	3 1 67890 002860	6
	39,1×32	30	PELPCO40GP	3 1 67890 002914	6
	49,3×42	62,2	PELPCO50GP	3 1 67890 002969	4
● limestone	25×24	8,7	PELPCO25CAL	3 1 67890 002884	6
	39,1×32	30	PELPCO40CAL	3 1 67890 002938	6
	49,3×42	62,2	PELPCO50CAL	3 1 67890 002983	4
● white	25×24	8,7	PELPCO25BL	3 1 67890 034854	6
	39,1×32	30	PELPCO40BL	3 1 67890 034861	6
	49,3×42	62,2	PELPCO50BL	3 1 67890 034878	4
● concrete	25×24	8,7	PELPCO25BT	3 1 67890 002853	6
	39,1×32	30	PELPCO40BT	3 1 67890 002907	6
	49,3×42	62,2	PELPCO50BT	3 1 67890 002952	4

Ø×H	C-CODE	EAN	
23,2×1,6	SPEL23AR	3 1 67890 001795	6
37,8×2,4	SPEL38AR	3 1 67890 001979	6
47,1×2,9	SPEL47AR	3 1 67890 002075	4
23,2×1,6	SPEL23GP	3 1 67890 001764	6
37,8×2,4	SPEL38GP	3 1 67890 001924	6
47,1×2,9	SPEL47GP	3 1 67890 002044	4
23,2×1,6	SPEL23CAL	3 1 67890 001788	6
37,8×2,4	SPEL38CAL	3 1 67890 001962	6
47,1×2,9	SPEL47CAL	3 1 67890 002068	4
23,2×1,6	SPEL23BL	3 1 67890 034885	6
37,8×2,4	SPEL38BL	3 1 67890 034892	6
47,1×2,9	SPEL47BL	3 1 67890 034908	4
23,2×1,6	SPEL23BT	3 1 67890 001757	6
37,8×2,4	SPEL38BT	3 1 67890 001917	6
47,1×2,9	SPEL47BT	3 1 67890 002037	4

New colour



A developed relief to avoid stagnation water under the pot. Water reserve adaptable to the needs of the plant.

Un relief développé pour éviter la stagnation de l'eau sous le pot. Réserve d'eau adaptable aux besoins des plantes.

Eine Rinne am Boden verhindert Staunässe unter dem Topf. Wasserreserve kann an die Bedürfnisse der Pflanzen angepasst werden.

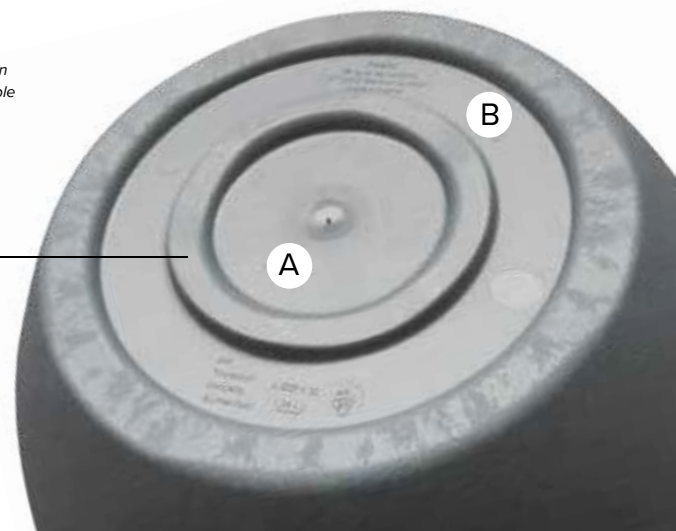
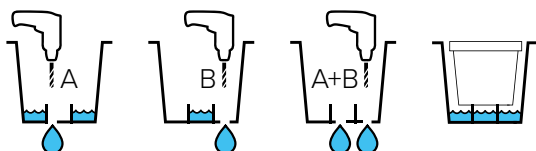

WINDOW BOX

JARDINIÈRE / BLUMENKASTEN



COLOUR	L×W×H	••• L	C-CODE	EAN	
 slate	59,5×21,4×24	23,7	JELP60AR	3 167890 0111091	5
 graphite	59,5×21,4×24	23,7	JELP60GP	3 167890 0111138	5
 limestone	59,5×21,4×24	23,7	JELP60CAL	3 167890 0111121	5
 white	59,5×21,4×24	23,7	JELP60BL	3 167890 036230	5
 concrete	59,5×21,4×24	23,7	JELP60BT	3 167890 0111107	5

L×W×H	C-CODE	EAN	
60,5×24×2,4	SJEL60AR	3 167890 010759	5
60,5×24×2,4	SJEL60GP	3 167890 010797	5
60,5×24×2,4	SJEL60CAL	3 167890 010780	5
60,5×24×2,4	SJEL60BL	3 167890 036254	5
60,5×24×2,4	SJEL60BT	3 167890 010766	5



Good proportions for good plant growth
 Grand volume de terre pour un bon épanouissement des plantes
 Ideale Größe für bestes Pflanzenwachstum

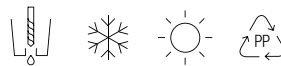

BOWL

COUPE / PFLANZSCHALE



COLOUR	Ø×H	••• L	C-CODE	EAN	
 slate	38,9×16,4	13	CELP40AR	3 167890 0111046	6
 graphite	38,9×16,4	13	CELP40GP	3 167890 0111084	6
 limestone	38,9×16,4	13	CELP40CAL	3 167890 0111077	6
 white	38,9×16,4	13	CELP40BL	3 167890 036223	6
 concrete	38,9×16,4	13	CELP40BT	3 167890 0111053	6

Ø×H	C-CODE	EAN	
25,1×1,6	SPEL25AR	3 167890 001856	5
25,1×1,6	SPEL25GP	3 167890 001818	5
25,1×1,6	SPEL25CAL	3 167890 001849	5
25,1×1,6	SPEL25BL	3 167890 036247	5
25,1×1,6	SPEL25BT	3 167890 001801	5



Grainy texture inside and out
 Grainée totalement intérieur-extérieur
 Strukturierte Oberfläche innen und außen





high quality
5
YEARS
GUARANTEE

gaïa

Gaïa collection offers a wide range of planters. With various textures, they are made for mini cactuses and succulents – a perfect match for urban jungle lovers.

Une collection de cache-pots aux multiples effets de texture. Tendance jungle urbaine : l'association parfaite avec les minis cactus et succulentes.

Diese Serie umfasst Pflanzgefäße und Übertöpfe mit verschiedensten Strukturen für kleine Pflanzen und Kakteen – urbanes Jungle-Feeling garantiert.









clawed

GRIFFÉ / KRATZER



CONICAL PLANTER

CACHE-POT CONIQUE / BLUMENTOPF KONISCH

COLOUR	Ø×H	•••L	C-CODE	EAN	
 khaki	7,2×6,5	0,2	PGAPGR7KA	3 167890 011176	6
 terracotta	7,2×6,5	0,2	PGAPGR7TE	3 167890 011169	6
 graphite	7,2×6,5	0,2	PGAPGR7GP	3 167890 011145	6
 cotton	7,2×6,5	0,2	PGAPGR7COT	3 167890 011152	6







striped

RAYÉ / GESTREIFT



ROUND PLANTER

CACHE-POT ROND / BLUMENTOPF RUND

COLOUR	Ø×H	•••L	C-CODE	EAN	
 khaki	12×9,8	0,7	PGAPRA12KA	3 167890 011374	6
 terracotta	12×9,8	0,7	PGAPRA12TE	3 167890 011367	6
 graphite	12×9,8	0,7	PGAPRA12GP	3 167890 011343	6
 cotton	12×9,8	0,7	PGAPRA12COT	3 167890 011350	6







marbled

MARBRÉ / MARMORIERT



CONICAL PLANTER

CACHE-POT CONIQUE / BLUMENTOPF KONISCH

COLOUR	Ø×H	•••L	C-CODE	EAN	
 khaki	14,5×13,1	1,5	PGAPMA15KA	3 167890 011251	6
 terracotta	14,5×13,1	1,5	PGAPMA15TE	3 167890 011244	6
 graphite	14,5×13,1	1,5	PGAPMA15GP	3 167890 011220	6
 cotton	14,5×13,1	1,5	PGAPMA15COT	3 167890 011237	6













crackled

CRAQUELÉ / RISSIG

ROUND PLANTER

CACHE-POT ROND / BLUMENTOPF RUND



COLOUR	Ø×H	••• L	C-CODE	EAN	
 khaki	13,6×13,1	1,5	PGAPCR14KA	 3 1 6 7 8 9 0 1 1 1 2 9 9	6
 terracotta	13,6×13,1	1,5	PGAPCR14TE	 3 1 6 7 8 9 0 1 1 1 2 8 2	6
 graphite	13,6×13,1	1,5	PGAPCR14GP	 3 1 6 7 8 9 0 1 1 1 2 6 8	6
 cotton	13,6×13,1	1,5	PGAPCR14COT	 3 1 6 7 8 9 0 1 1 1 2 7 5	6



wheeled

TOURNÉ / GEDREHT

BOWL

COUPE / PFLANZSCHALE



COLOUR	Ø×H	••• L	C-CODE	EAN	
 khaki	18×8,2	1,4	PGAPTO18KA	 3 1 6 7 8 9 0 1 1 1 2 1 3	6
 terracotta	18×8,2	1,4	PGAPTO18TE	 3 1 6 7 8 9 0 1 1 1 2 0 6	6
 graphite	18×8,2	1,4	PGAPTO18GP	 3 1 6 7 8 9 0 1 1 1 1 8 3	6
 cotton	18×8,2	1,4	PGAPTO18COT	 3 1 6 7 8 9 0 1 1 1 1 9 0	6



zebra

ZEBRÉ / ZEBRA

ROUND PLANTER

CACHE-POT ROND / BLUMENTOPF RUND



COLOUR	Ø×H	••• L	C-CODE	EAN	
 khaki	14,5×10,7	1,2	PGAPZE15KA	 3 1 6 7 8 9 0 1 0 3 6 4 7 6	6
 terracotta	14,5×10,7	1,2	PGAPZE15TE	 3 1 6 7 8 9 0 1 0 3 6 4 9 0	6
 graphite	14,5×10,7	1,2	PGAPZE15GP	 3 1 6 7 8 9 0 1 0 3 6 5 0 6	6
 cotton	14,5×10,7	1,2	PGAPZE15COT	 3 1 6 7 8 9 0 1 0 3 6 4 8 3	6

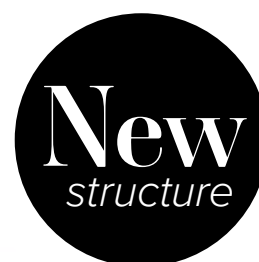
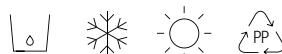





high quality
5
YEARS
GUARANTEE

material



ROUND PLANTER

POT ROND / BLUMENKÜBEL RUND

COLOUR	Ø×H	••• L	C-CODE	EAN	
cement	23,7×25,8	7	PMA24CI		6
	30,4×32,8	15	PMA30CI		5
	37,9×41	30	PMA38CI		4
slate	23,7×25,8	7	PMA24AR		6
	30,4×32,8	15	PMA30AR		5
	37,9×41	30	PMA38AR		4
corten	23,7×25,8	7	PMA24COR		6
	30,4×32,8	15	PMA30COR		5
	37,9×41	30	PMA38COR		4



Stopper with overflow
for indoor and outdoor use
Bouchon avec trop plein pour
une utilisation intérieure et extérieure
Kappe mit Überlauf zur Nutzung
für den Innen- und Außenbereich



The natural look created in this product line imitates raw material to perfection. Perfect for an indoor and outdoor decoration in industrial style. The manufacturing process ensures an excellent resistance to shocks, frost and UV.

D'aspect naturel, les effets de surface imitent à la perfection les matériaux bruts. Pour une déco intérieure ou extérieure au style industriel. Le procédé de fabrication permet une excellente résistance aux chocs, au gel et aux UV.

Perfekte Imitation von Rohstoffen durch natürlich aussehende Oberflächen. Für eine Innen- und Außendekoration im Industrial Look. Der Produktionsprozess gewährleistet eine Beständigkeit gegen Schlag, Frost und UV-Strahlen.



01 MODERN CASA MESH







casa mesh





CUBE PLANTER

BAC CARRÉ / WÜRFEL

COLOUR	L×W×H	•••L L	C-CODE	EAN	
 white	29,9×29,9×31,3	12 2,8	BCME30BL	 3 1 67890 013996	1
 granite	29,9×29,9×31,3	12 2,8	BCME30GRA	 3 1 67890 014009	1
 mocca	29,9×29,9×31,3	12 2,8	BCME30MK	 3 1 67890 014016	1



System solution with integrated recessed handles
Avec insert de plantation
Pflanzeinsatz mit integrierten Griffmulden



Integrated watering kit with level indicator with filling chamber







Kit d'irrigation d'eau avec indicateur de niveau d'eau et entonnoir

Integriertes Bewässerungs-Kit mit Wasserstandsanzeige inkl. Füllschacht



COLUMN PLANTER

BAC CARRÉ HAUT / SÄULE

COLOUR	L×W×H	•••L L	C-CODE	EAN	
 white	29,9×29,9×57,4	12 2,8	BCMEP3058BL	 3 1 67890 014023	1
 granite	29,9×29,9×57,4	12 2,8	BCMEP3058GRA	 3 1 67890 014030	1
 mocca	29,9×29,9×57,4	12 2,8	BCMEP3058MK	 3 1 67890 014047	1



System solution with integrated recessed handles
Avec insert de plantation
Pflanzeinsatz mit integrierten Griffmulden









100% recycled 

01 MODERN CASA MESH 



WINDOW BOX

JARDINIÈRE / BLUMENKASTEN

COLOUR	L×W×H	••• L L	C-CODE	EAN	
 white	49,8×19,8×18,3	10 2,5	JCME50BL	3 1 67890 014054	5
	74,8×19,8×18,3	15,6 4	JCME75BL	3 1 67890 014061	5
 granite	49,8×19,8×18,3	10 2,5	JCME50GRA	3 1 67890 014078	5
	74,8×19,8×18,3	15,6 4	JCME75GRA	3 1 67890 014085	5
 mocca	49,8×19,8×18,3	10 2,5	JCME50MK	3 1 67890 014092	5
	74,8×19,8×18,3	15,6 4	JCME75MK	3 1 67890 014108	5

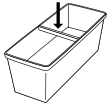

75 cm
With reinforcement rod
Avec traverse de renfort
Mit Verstärkungsstrebe





SPECIAL for Casa Mesh & My City Garden

Matching brackets
Supports de jardinière assorties
Der passende Kastenhalter
P. / S. 139

RAILING POT

POT POUR BALUSTRADE / GELÄNDERTOPF



COLOUR	L×W×H	••• L L	C-CODE	EAN	
 white	29,6×29,6×26,2	9 0,6	PBCME30BL	3 1 67890 014122	5
	29,6×29,6×26,2	9 0,6	PBCME30GRA	3 1 67890 014139	5
 granite	29,6×29,6×26,2	9 0,6	PBCME30GRA	3 1 67890 014139	5
	29,6×29,6×26,2	9 0,6	PBCME30MK	3 1 67890 014146	5

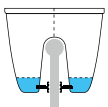

Large planting volume
also in the centre part
Grande profondeur de plantation
même dans la partie centrale
Großes Pflanzvolumen auch im Mittelteil





casa brilliant



ROUND PLANTER

POT ROND / BLUMENKÜBEL RUND

AUTHENTIC
GLOSS



COLOUR	Ø×H	•••L	•L	C-CODE	EAN	☐
white	24,8×22	7	1,5	PCBR25BL	3 1 67890 014153	3
	29,8×26,5	12,6	2,1	PCBR30BL	3 1 67890 014160	3
	36×31,5	22,6	3	PCBR36BL	3 1 67890 014177	2
granite	24,8×22	7	1,5	PCBR25GRA	3 1 67890 014184	3
	29,8×26,5	12,6	2,1	PCBR30GRA	3 1 67890 014191	3
	36×31,5	22,6	3	PCBR36GRA	3 1 67890 014214	2
ruby	24,8×22	7	1,5	PCBR25RU	3 1 67890 014221	3
	29,8×26,5	12,6	2,1	PCBR30RU	3 1 67890 014238	3
	36×31,5	22,6	3	PCBR36RU	3 1 67890 014245	2
silk grey	24,8×22	7	1,5	PCBR25GS	3 1 67890 014252	3
	29,8×26,5	12,6	2,1	PCBR30GS	3 1 67890 014269	3
	36×31,5	22,6	3	PCBR36GS	3 1 67890 014276	2



COLUMN PLANTER

BAC CARRÉ HAUT / SÄULE

AUTHENTIC
GLOSS



COLOUR	L×W×H	•••L	•L	C-CODE	EAN	☐
white	29,9×29,9×57,4	12	2,8	BCBRP3058BL	3 1 67890 014283	1
granite	29,9×29,9×57,4	12	2,8	BCBRP3058GRA	3 1 67890 014290	1
ruby	29,9×29,9×57,4	12	2,8	BCBRP3058RU	3 1 67890 014313	1
silk grey	29,9×29,9×57,4	12	2,8	BCBRP3058GS	3 1 67890 014320	1



System solution with integrated recessed handles
Avec insert de plantation
Pflanzensatz mit integrierten Griffmulden





100% recycled

casa
mat

CUBE PLANTER

BAC CARRÉ / WÜRFEL

COLOUR	L×W×H	•••L	•L	C-CODE	EAN	
 white	29,9×29,9×31,3	12	2,8	BCMA30BL	3 1 67890 014337	1
 granite	29,9×29,9×31,3	12	2,8	BCMA30GRA	3 1 67890 014344	1
 silk grey	29,9×29,9×31,3	12	2,8	BCMA30GS	3 1 67890 014368	1



System solution with integrated recessed handles

Avec insert de plantation

Pflanzeinsatz mit integrierten Griffmulden



COLUMN PLANTER

BAC CARRÉ HAUT / SÄULE



COLOUR	L×W×H	•••L	•L	C-CODE	EAN	
 white	29,9×29,9×57,4	12	2,8	BCMAP3058BL	3 1 67890 014375	1
 granite	29,9×29,9×57,4	12	2,8	BCMAP3058GRA	3 1 67890 014382	1
 silk grey	29,9×29,9×57,4	12	2,8	BCMAP3058GS	3 1 67890 014399	1



System solution with integrated recessed handles

Avec insert de plantation

Pflanzeinsatz mit integrierten Griffmulden







casa COSY



ROUND PLANTER

POT ROND / BLUMENKÜBEL RUND

COLOUR	Ø×H	•••L	L	C-CODE	EAN	
 white	24,8×22	7	1,5	PCCO25BL	3 167890 013828	3
	29,8×26,5	12,6	2,1	PCCO30BL	3 167890 013859	3
	36×31,5	22,6	3	PCCO36BL	3 167890 013880	2
 granite	24,8×22	7	1,5	PCCO25GRA	3 167890 013835	3
	29,8×26,5	12,6	2,1	PCCO30GRA	3 167890 013866	3
	36×31,5	22,6	3	PCCO36GRA	3 167890 013897	2
 silk grey	24,8×22	7	1,5	PCCO25GS	3 167890 013842	3
	29,8×26,5	12,6	2,1	PCCO30GS	3 167890 013873	3
	36×31,5	22,6	3	PCCO36GS	3 167890 013903	2



CUBE PLANTER

BAC CARRÉ / WÜRFEL



COLOUR	L×W×H	•••L	L	C-CODE	EAN	
 white	29,9×29,9×31,3	12	2,8	BCCO30BL	3 167890 013958	1
	29,9×29,9×31,3	12	2,8	BCCO30GRA	3 167890 013965	1
	29,9×29,9×31,3	12	2,8	BCCO30GS	3 167890 013989	1



System solution with integrated recessed handles
Avec insert de plantation
Pflanzeinsatz mit integrierten Griffmulden



COLUMN PLANTER

BAC CARRÉ HAUT / SÄULE



COLOUR	L×W×H	•••L	L	C-CODE	EAN	
 white	29,9×29,9×57,4	12	2,8	BCCOP3058BL	3 167890 013910	1
	29,9×29,9×57,4	12	2,8	BCCOP3058GRA	3 167890 013927	1
	29,9×29,9×57,4	12	2,8	BCCOP3058GS	3 167890 013941	1



System solution with integrated recessed handles
Avec insert de plantation
Pflanzeinsatz mit integrierten Griffmulden



casa authentic



Deceptively real surfaces in industrial design for a sharp, modern look



Des effets de matières brutes associés à un design moderne et épuré pour une déco au style industriel

Täuschend echte Oberflächen im Industrial Design für einen klaren, modernen Look



COLUMN PLANTER

BAC CARRÉ HAUT / SÄULE

COLOUR	L×W×H	••• L L	C-CODE	EAN	☐
 corten	29,9×29,9×57,4	12 2,8	BCAUP3058COR	 3 1 67896 017420	1



System solution with integrated recessed handles
 Avec insert de plantation
 Pflanzeinsatz mit integrierten Griffmulden







COLUMN PLANTER

BAC CARRÉ HAUT / SÄULE



COLOUR	L×W×H	☼ L	💧 L	C-CODE	EAN	
 cement	29,9×29,9×57,4	12	2,8	BCAUP3058CI	 3 167890 017413	1



System solution with integrated recessed handles

Avec insert de plantation



Pflanzeinsatz mit integrierten Griffmulden



COLUMN PLANTER

BAC CARRÉ HAUT / SÄULE



COLOUR	L×W×H	☼ L	💧 L	C-CODE	EAN	
 slate	29,9×29,9×57,4	12	2,8	BCAUP3058AR	 3 167890 042651	1



System solution with integrated recessed handles

Avec insert de plantation

Pflanzeinsatz mit integrierten Griffmulden



01 MODERN CASA SLEEVE



1 casa sleeve

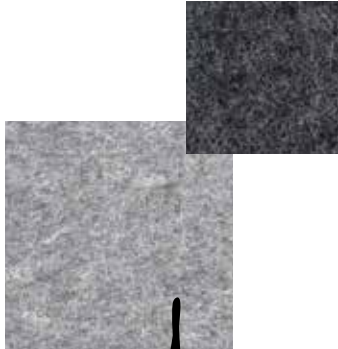

indoor







ROUND PLANTER

POT ROND / BLUMENKÜBEL RUND

The CASA Sleeve range combines the advantages of recycled plastic (lightness, robustness, waterproofing) and the naturalness of its textile coating. Its original and carefully finished seam brings elegance and aestheticism.

La gamme CASA Sleeve allie avantage du plastique recyclé (légèreté, robustesse, étanchéité) et originalité grâce à son revêtement textile unique. Sa couture originale et soigneusement finie apporte élégance et esthétique.

Die Serie CASA Sleeve kombiniert die Vorteile von recyceltem Kunststoff (Leichtigkeit, Robustheit, Dichtheit) und die Natürlichkeit des textilen Überzugs. Die sorgfältig verarbeitete Naht schafft Eleganz und Ästhetik.

COLOUR	Ø×H	••• L	💧 L	C-CODE	EAN	
 slate	26,2×21,7	6,5	1,5	PCSL25SLA	3 1 6 7 8 9 0 0 1 7 4 3 7	3
	31,3×26	12	2,2	PCSL30SLA	3 1 6 7 8 9 0 0 1 7 4 6 8	3
	36,7×31,2	15,5	3	PCSL36SLA	3 1 6 7 8 9 0 0 1 7 4 9 9	3
 mud	26,2×21,7	6,5	1,5	PCSL25MUD	3 1 6 7 8 9 0 0 1 7 4 4 4	3
	31,3×26	12	2,2	PCSL30MUD	3 1 6 7 8 9 0 0 1 7 4 7 5	3
	36,7×31,2	15,5	3	PCSL36MUD	3 1 6 7 8 9 0 0 1 7 5 0 5	3
 ash	26,2×21,7	6,5	1,5	PCSL25ASH	3 1 6 7 8 9 0 0 1 7 4 5 1	3
	31,3×26	12	2,2	PCSL30ASH	3 1 6 7 8 9 0 0 1 7 4 8 2	3
	36,7×31,2	15,5	3	PCSL36ASH	3 1 6 7 8 9 0 0 1 7 5 1 2	3



Stable base
Base stable
Stabiler Körper





origine

Rotomoulded – high thickness and ultra resistant

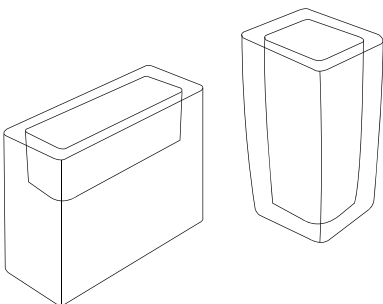

Rotomoulé – forte épaisseur et ultra résistant

Rotationsgeformt – extrem widerstandsfähig durch eine sehr hohe Materialdicke



COLUMN PLANTER XXL

BAC CARRÉ HAUT XXL / XXL SÄULE

COLOUR	L×W×H	❖L	C-CODE	EAN	🪴
 anthracite	59×59×88	114	BCOR60NV	3 167896 008367	1
 taupe	59×59×88	114	BCOR60TA	3 167896 008411	1
 red morello	59×59×88	114	BCOR60GT	3 167896 008336	1





XXL
planters

ORIGINE is the assurance of a very contemporary decoration. Ideal to organise spaces on balconies and terraces. Using the rotational moulding technique, ORIGINE planters have a double wall for unequalled resistance.



ORIGINE, c'est l'assurance d'une déco ultra-contemporaine. Idéal pour aménager les terrasses et délimiter les grands espaces. Fabriqués grâce à la technique de rotomoulage, ces bacs bénéficient d'une double paroi pour une résistance inégalée.

ORIGINE, für eine sehr moderne und zeitgenössische Dekoration. Ideal, um Flächen auf Balkonen und Terrassen zu organisieren. Die im Rotationsformverfahren hergestellten ORIGINE-Pflanzgefäße haben eine Doppelwand für eine unvergleichliche Widerstandsfähigkeit.

RECTANGULAR PLANTER XXL

BAC RECTANGULAIRE XXL / XXL BLUMENKÜBEL ECKIG



COLOUR	L×W×H	••• L	C-CODE	EAN	
 black	84×33×68,3	30	BOR80N	3 167890 003515	1
 white	84×33×68,3	30	BOR80BL	3 167890 003508	1



Elevated bottom
Fond surélevé
Erhöhter Boden





easy
gardie



ning



Both functional and decorative: here are the essentials for terraces, gardens and balconies! Colourful, easy-to-use and accessible product ranges: there's something for every style!

À la fois fonctionnels et déco : voici les incontournables des terrasses, jardins et balcons ! Des gammes de produits colorés, simples d'utilisation et accessibles à tous : il y en a pour tous les styles !

Funktional und dekorativ zugleich: Ein absolutes Muss für Terrassen, Gärten und Balkone! Farbenfrohe und praktische Produktreihen – passend für jeden Stil!



new

ECO-FRIENDLY
LIFE
STYLE

JOY, the range that makes your shelves shine. Authentic and inspiring colours to bring the outdoors to life. Colourful and decorative, of course, but also environmentally friendly: the JOY range is made entirely from recycled material! 5 colours* are even produced exclusively from post-consumer material. Our everyday waste becomes our greatest resource!

JOY, la gamme qui ravive les rayons. Des couleurs authentiques et inspirantes pour donner vie aux extérieurs. Colorée et déco, certes, mais aussi écolo : la gamme JOY est entièrement fabriquée à partir de matière recyclée ! 5 couleurs* sont même produites exclusivement avec de la matière post-consommation. Nos déchets de tous les jours deviennent nos plus grandes ressources !

JOY, die Serie, welche die Regale strahlen lässt. Authentische und inspirierende Farben erwecken den Außenbereich zum Leben. Farbenfroh und dekorativ, zusätzlich auch umweltfreundlich: die Reihe JOY wird komplett aus recyceltem Material hergestellt! 5 Farben* werden allesamt und ausschließlich aus Post-Consumer-Material hergestellt. Unser täglicher Abfall wird zu unserer größten Ressource!

(*Colours : granite, taupe, khaki, blue jean and terracotta)



7
SIZES
8
colours

GOOD TO KNOW

BON À SAVOIR
GUT ZU WISSEN

1.  **MADE
WITH 100%
CONSUMER
WASTE**

*Fabriqué en matière 100% recyclée
post-consommation*

*Aus 100% recyceltem Kunststoff
(Post-Consumer)*





2. BOTTOM WITH WATER RESERVOIR

*Fond à réserve d'eau
Innovatives Bodendesign
P. / S. 48*



3. ATTACHABLE ROLLERS FOR BIG SIZES

*Compatibles avec les grandes tailles
PJO35 à PJO60*

*Rollen optional für große Größen
PJO35 bis PJO60
P. / S. 55*



4. A FINELY CRAFTED TEXTURE

*Une texture finement travaillée
Eine fein gearbeitete Textur*



5. SAUCER COMBINED HARMONIOUSLY

*Soucoupe esthétique adaptée
Harmonisch kombinierbare Untersetzer*

02 EASY JOY

New
SERIES



100%
recycled 

joy

ROUND PLANTER
POT ROND / BLUMENKÜBEL RUND



COLOUR	Ø×H	L	C-CODE	EAN	
white	19,2×15,8	2,9	PJO20BL	3 167890 030573	10
	24,6×20,3	6,2	PJO25BL	3 167890 030634	8
	29×24	10,2	PJO30BL	3 167890 030702	8
	34,4×28,4	17	PJO35BL	3 167890 030764	8
	38,6×31,2	25	PJO40BL	3 167890 030832	5
	48,8×40,6	49,8	PJO50BL	3 167890 030894	5
	58,8×48,8	86,2	PJO60BL	3 167890 030962	5
taupe	19,2×15,8	2,9	PJO20TA	3 167890 030542	10
	24,6×20,3	6,2	PJO25TA	3 167890 030597	8
	29×24	10,2	PJO30TA	3 167890 030665	8
	34,4×28,4	17	PJO35TA	3 167890 030726	8
	38,6×31,2	25	PJO40TA	3 167890 030788	5
	48,8×40,6	49,8	PJO50TA	3 167890 030849	5
	58,8×48,8	86,2	PJO60TA	3 167890 030917	5
granite	19,2×15,8	2,9	PJO20GRA	3 167890 026149	10
	24,6×20,3	6,2	PJO25GRA	3 167890 026156	8
	29×24	10,2	PJO30GRA	3 167890 026163	8
	34,4×28,4	17	PJO35GRA	3 167890 026170	8
	38,6×31,2	25	PJO40GRA	3 167890 026187	5
	48,8×40,6	49,8	PJO50GRA	3 167890 026217	5
	58,8×48,8	86,2	PJO60GRA	3 167890 026248	5
sunflower	19,2×15,8	2,9	PJO20TO	3 167890 030559	10
	24,6×20,3	6,2	PJO25TO	3 167890 030603	8
	29×24	10,2	PJO30TO	3 167890 030672	8
	34,4×28,4	17	PJO35TO	3 167890 030733	8
	38,6×31,2	25	PJO40TO	3 167890 030795	5
	48,8×40,6	49,8	PJO50TO	3 167890 030863	5
	58,8×48,8	86,2	PJO60TO	3 167890 030924	5

Ø×H	C-CODE	EAN	
14,8×1,9	SPJO20BL	3 167890 031143	10
18,9×2,4	SPJO25BL	3 167890 034816	8
22,5×3	SPJO30BL	3 167890 035295	8
26,6×3,4	SPJO35BL	3 167890 035356	8
30×3,8	SPJO40BL	3 167890 035417	5
38×4,8	SPJO50BL	3 167890 035479	5
45,6×5,8	SPJO60BL	3 167890 035547	5
14,8×1,9	SPJO20TA	3 167890 030993	10
18,9×2,4	SPJO25TA	3 167890 031235	8
22,5×3	SPJO30TA	3 167890 034922	8
26,6×3,4	SPJO35TA	3 167890 035318	8
30×3,8	SPJO40TA	3 167890 035370	5
38×4,8	SPJO50TA	3 167890 035431	5
45,6×5,8	SPJO60TA	3 167890 035509	5
14,8×1,9	SPJO20GRA	3 167890 026323	10
18,9×2,4	SPJO25GRA	3 167890 026330	8
22,5×3	SPJO30GRA	3 167890 026361	8
26,6×3,4	SPJO35GRA	3 167890 026378	8
30×3,8	SPJO40GRA	3 167890 026385	5
38×4,8	SPJO50GRA	3 167890 026392	5
45,6×5,8	SPJO60GRA	3 167890 026408	5
14,8×1,9	SPJO20TO	3 167890 031006	10
18,9×2,4	SPJO25TO	3 167890 031242	8
22,5×3	SPJO30TO	3 167890 035264	8
26,6×3,4	SPJO35TO	3 167890 035325	8
30×3,8	SPJO40TO	3 167890 035387	5
38×4,8	SPJO50TO	3 167890 035448	5
45,6×5,8	SPJO60TO	3 167890 035516	5





Base with relief to avoid water stagnation under the pot.
Water reserve adaptable to the needs of the plant.

*Base avec relief pour éviter la stagnation de l'eau sous le pot.
Réserve d'eau adaptable aux besoins des plantes.*

*Boden mit Relief, um Wasserstau unter dem Topf zu vermeiden.
Wasserreserve kann an die Bedürfnisse der Pflanzen angepasst werden.*

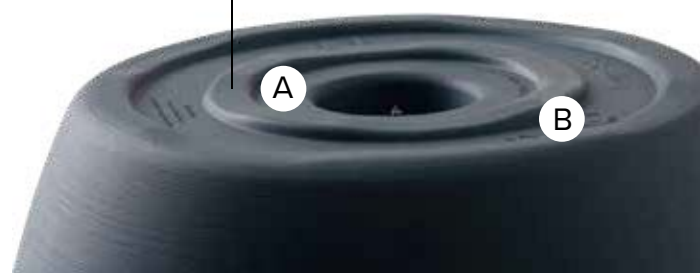
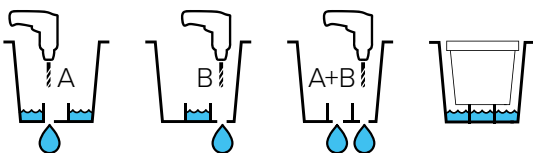



ROUND PLANTER

POT ROND / BLUMENKÜBEL RUND



COLOUR	Ø×H	••• L	C-CODE	EAN		Ø×H	C-CODE	EAN	
cherry	19,2×15,8	2,9	PJO20CE	3 167890 035561	10	14,8×1,9	SPJO20CE	3 167890 035639	10
	24,6×20,3	6,2	PJO25CE	3 167890 035578	8	18,9×2,4	SPJO25CE	3 167890 035646	8
	29×24	10,2	PJO30CE	3 167890 035585	8	22,5×3	SPJO30CE	3 167890 035660	8
	34,4×28,4	17	PJO35CE	3 167890 035592	8	26,6×3,4	SPJO35CE	3 167890 035677	8
	38,6×31,2	25	PJO40CE	3 167890 035608	5	30×3,8	SPJO40CE	3 167890 035684	5
	48,8×40,6	49,8	PJO50CE	3 167890 035615	5	38×4,8	SPJO50CE	3 167890 035691	5
	58,8×48,8	86,2	PJO60CE	3 167890 035622	5	45,6×5,8	SPJO60CE	3 167890 035707	5
khaki	19,2×15,8	2,9	PJO20KA	3 167890 030566	10	14,8×1,9	SPJO20KA	3 167890 031044	10
	24,6×20,3	6,2	PJO25KA	3 167890 030610	8	18,9×2,4	SPJO25KA	3 167890 031259	8
	29×24	10,2	PJO30KA	3 167890 030689	8	22,5×3	SPJO30KA	3 167890 035271	8
	34,4×28,4	17	PJO35KA	3 167890 030740	8	26,6×3,4	SPJO35KA	3 167890 035332	8
	38,6×31,2	25	PJO40KA	3 167890 030801	5	30×3,8	SPJO40KA	3 167890 035394	5
	48,8×40,6	49,8	PJO50KA	3 167890 030870	5	38×4,8	SPJO50KA	3 167890 035455	5
	58,8×48,8	86,2	PJO60KA	3 167890 030931	5	45,6×5,8	SPJO60KA	3 167890 035523	5
terracotta	19,2×15,8	2,9	PJO20TS	3 167890 030535	10	14,8×1,9	SPJO20TS	3 167890 030986	10
	24,6×20,3	6,2	PJO25TS	3 167890 030580	8	18,9×2,4	SPJO25TS	3 167890 031204	8
	29×24	10,2	PJO30TS	3 167890 030658	8	22,5×3	SPJO30TS	3 167890 034915	8
	34,4×28,4	17	PJO35TS	3 167890 030719	8	26,6×3,4	SPJO35TS	3 167890 035301	8
	38,6×31,2	25	PJO40TS	3 167890 030771	5	30×3,8	SPJO40TS	3 167890 035363	5
	48,8×40,6	49,8	PJO50TS	3 167890 030856	5	38×4,8	SPJO50TS	3 167890 035424	5
	58,8×48,8	86,2	PJO60TS	3 167890 030900	5	45,6×5,8	SPJO60TS	3 167890 035493	5
blue jean	19,2×15,8	2,9	PJO20BJ	3 167890 030641	10	14,8×1,9	SPJO20BJ	3 167890 031075	10
	24,6×20,3	6,2	PJO25BJ	3 167890 030627	8	18,9×2,4	SPJO25BJ	3 167890 034809	8
	29×24	10,2	PJO30BJ	3 167890 030696	8	22,5×3	SPJO30BJ	3 167890 035288	8
	34,4×28,4	17	PJO35BJ	3 167890 030757	8	26,6×3,4	SPJO35BJ	3 167890 035349	8
	38,6×31,2	25	PJO40BJ	3 167890 030825	5	30×3,8	SPJO40BJ	3 167890 035400	5
	48,8×40,6	49,8	PJO50BJ	3 167890 030887	5	38×4,8	SPJO50BJ	3 167890 035462	5
	58,8×48,8	86,2	PJO60BJ	3 167890 030948	5	45,6×5,8	SPJO60BJ	3 167890 035530	5



02 EASY ROMÉO

100%
recycled 

ROMÉO, a classic for terraces that can be used for any purpose! Its original curve and varied colours bring plants to life. Available in many sizes and shapes, the combinations are endless!

ROMÉO, un classique incontournable des terrasses qui répond à tous les usages ! Sa courbe originale et ses couleurs variées, donnent vie aux végétaux. Décliné dans de nombreuses tailles et différentes formes, les combinaisons sont infinies !

ROMÉO, ein Klassiker für Terrassen und Balkone, der für jeden Zweck verwendet werden kann! Seine originelle Formsprache und die vielfältigen Farben erwecken Pflanzen zum Leben. In vielen Größen und Formen erhältlich, die Kombinationen sind endlos!



roméo

ROUND PLANTER

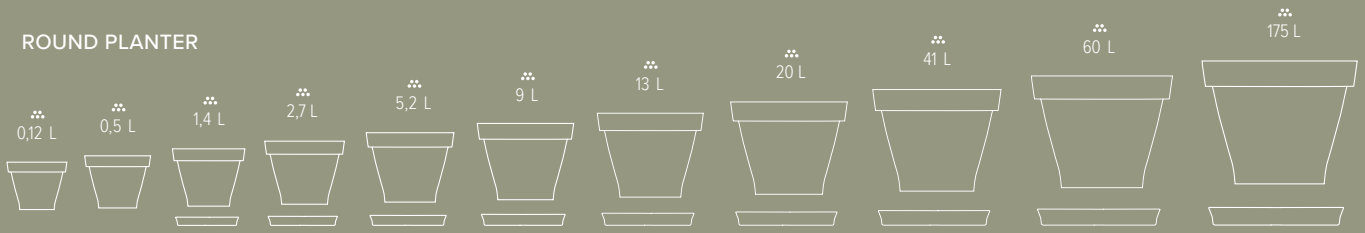

● ● ● ● ● P./S. 53 – 55

SQUARE PLANTER



WINDOW BOX



● ● ● ● ● P./S. 57

● ● ● ● ● P./S. 59

WINDOW BOX + CLIP ON TRAY

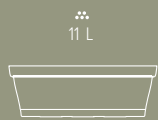

WINDOW BOX + SUPPORT + CLIP ON TRAY

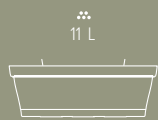

MINI WINDOW BOX + CLIP ON TRAY



MINI WINDOW BOX + SUPPORT + CLIP ON TRAY



BIG WINDOW BOX



● ● ● ● ● P./S. 60

● ● ● ● ● P./S. 61

● ● ● ● ● P./S. 62

● ● ● ● ● P./S. 62

● ● ● ● ● P./S. 63

RECTANGULAR PLANTER

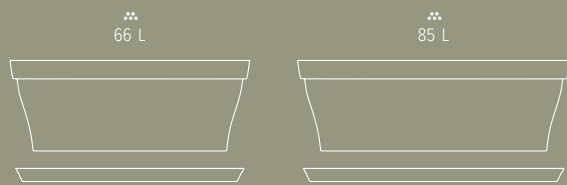

HIGH RECTANGULAR PLANTER



● ● ● ● ● P./S. 64

● ● ● ● ● P./S. 65

COLUMN ROUND PLANTER

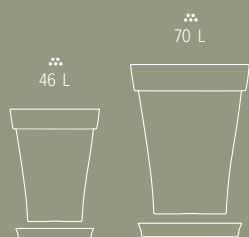

COLUMN SQUARE PLANTER

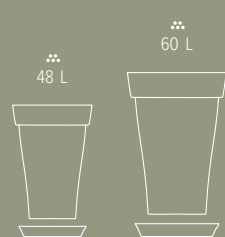

ROUND PLANTER XXL

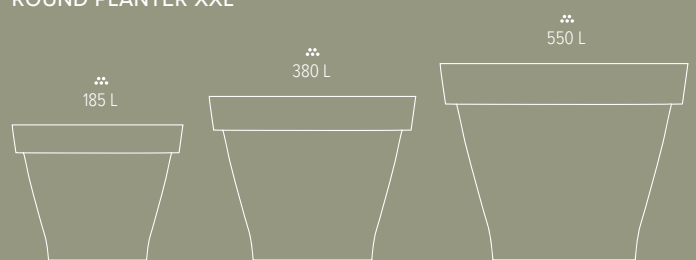

● ● ● ● ● P./S. 66

● ● ● ● ● P./S. 66

● ● ● ● ● P./S. 67



ROUND PLANTER
POT ROND / BLUMENKÜBEL RUND



COLOUR	Ø×H	L	C-CODE	EAN	
granite	7,7×6	0,12	PRO7NV	3 167897 931132	20
	11,7×9,4	0,5	PRO12NV	3 167898 731137	20
	16,5×13,2	1,4	PRO17NV	3 167891 831100	10
	21×16,3	2,7	PRO21NV	3 167892 631105	10
	24,5×19,5	5,2	PRO25NV	3 167893 331080	8
	29×23,4	9	PRO30NV	3 167893 431087	8
	33×26,2	13	PRO35NV	3 167893 531084	8
	39×31,2	20	PRO40NV	3 167893 631081	5
	49×38,5	41	PRO50NV	3 167893 731088	5
	59×46,2	60	PRO60NV	3 167890 031129	5
78×62	175	PRO80NV	3 167893 231182	4	
taupe	7,7×6	0,12	PRO7TA	3 167898 031138	20
	11,7×9,4	0,5	PRO12TA	3 167898 831134	20
	16,5×13,2	1,4	PRO17TA	3 167891 931107	10
	21×16,3	2,7	PRO21TA	3 167892 731102	10
	24,5×19,5	5,2	PRO25TA	3 167894 931081	8
	29×23,4	9	PRO30TA	3 167895 031087	8
	33×26,2	13	PRO35TA	3 167895 131084	8
	39×31,2	20	PRO40TA	3 167895 231081	5
	49×38,5	41	PRO50TA	3 167895 331088	5
	59×46,2	60	PRO60TA	3 167890 131126	5
78×62	175	PRO80TA	3 167893 331189	4	
sunflower	24,5×19,5	5,2	PRO25TO	3 167890 012487	8
	29×23,4	9	PRO30TO	3 167890 012500	8
	33×26,2	13	PRO35TO	3 167890 012524	8
	39×31,2	20	PRO40TO	3 167890 012548	5

Ø×H	C-CODE	EAN	
-	-	-	-
-	-	-	-
11,5×1,6	SPRO17NV	3 167893 431100	10
14,5×2,1	SPRO21NV	3 167894 231105	10
17,2×2,4	SPRO25NV	3 167894 131085	8
20,5×3	SPRO30NV	3 167894 231082	8
24,3×3,5	SPRO35NV	3 167894 331089	8
28×4	SPRO40NV	3 167894 431086	5
34,5×5	SPRO50NV	3 167894 531083	5
40,7×6	SPRO60NV	3 167890 831125	5
54×8	SPRO80NV	3 167894 131184	4
-	-	-	-
-	-	-	-
11,5×1,6	SPRO17TA	3 167893 531107	10
14,5×2,1	SPRO21TA	3 167894 331102	10
17,2×2,4	SPRO25TA	3 167895 731086	8
20,5×3	SPRO30TA	3 167895 831083	8
24,3×3,5	SPRO35TA	3 167895 931080	8
28×4	SPRO40TA	3 167896 031086	5
34,5×5	SPRO50TA	3 167896 131083	5
40,7×6	SPRO60TA	3 167890 931122	5
54×8	SPRO80TA	3 167894 231181	4
17,2×2,4	SPRO25TO	3 167890 012494	8
20,5×3	SPRO30TO	3 167890 012517	8
24,3×3,5	SPRO35TO	3 167890 012531	8
28×4	SPRO40TO	3 167890 012555	5



ROUND PLANTER
POT ROND / BLUMENKÜBEL RUND



COLOUR	Ø×H	L	C-CODE	EAN	
red morello	7,7×6	0,12	PRO7GT	3 167890 031167	20
	11,7×9,4	0,5	PRO12GT	3 167890 231161	20
	16,5×13,2	1,4	PRO17GT	3 167890 431165	10
	21×16,3	2,7	PRO21GT	3 167890 631169	10
	24,5×19,5	5,2	PRO25GT	3 167890 831163	8
	29×23,4	9	PRO30GT	3 167891 031166	8
	33×26,2	13	PRO35GT	3 167896 331155	8
	39×31,2	20	PRO40GT	3 167897 331154	5
	49×38,5	41	PRO50GT	3 167891 231160	5
	59×46,2	60	PRO60GT	3 167891 431164	5
78×62	175	PRO80GT	3 167893 831184	4	
khaki	7,7×6	0,12	PRO7KA	3 167890 011909	20
	11,7×9,4	0,5	PRO12KA	3 167890 011916	20
	16,5×13,2	1,4	PRO17KA	3 167890 011923	10
	21×16,3	2,7	PRO21KA	3 167890 011930	10
	24,5×19,5	5,2	PRO25KA	3 167890 011947	8
	29×23,4	9	PRO30KA	3 167890 011954	8
	33×26,2	13	PRO35KA	3 167890 011961	8
	39×31,2	20	PRO40KA	3 167890 011978	5
	49×38,5	41	PRO50KA	3 167890 011985	5
	59×46,2	60	PRO60KA	3 167890 011992	5
78×62	175	PRO80KA	3 167890 012005	4	

Ø×H	C-CODE	EAN	
-	-	-	-
-	-	-	-
11,5×1,6	SPRO17GT	3 167892 031165	10
14,5×2,1	SPRO21GT	3 167892 231169	10
17,2×2,4	SPRO25GT	3 167892 431163	8
20,5×3	SPRO30GT	3 167892 631167	8
24,3×3,5	SPRO35GT	3 167896 731153	8
28×4	SPRO40GT	3 167897 631155	5
34,5×5	SPRO50GT	3 167892 831161	5
40,7×6	SPRO60GT	3 167893 031164	5
54×8	SPRO80GT	3 167894 731186	4
-	-	-	-
-	-	-	-
11,5×1,6	SPRO17KA	3 167890 012012	10
14,5×2,1	SPRO21KA	3 167890 012029	10
17,2×2,4	SPRO25KA	3 167890 012036	8
20,5×3	SPRO30KA	3 167890 012043	8
24,3×3,5	SPRO35KA	3 167890 012050	8
28×4	SPRO40KA	3 167890 012067	5
34,5×5	SPRO50KA	3 167890 012074	5
40,7×6	SPRO60KA	3 167890 012081	5
54×8	SPRO80KA	3 167890 012098	4











ROUND PLANTER

POT ROND / BLUMENKÜBEL RUND

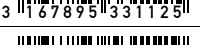

COLOUR	Ø×H	••• L	C-CODE	EAN	
 terracotta	7,7×6	0,12	PRO7TC		20
	11,7×9,4	0,5	PRO12TC		20
	16,5×13,2	1,4	PRO17TC		10
	21×16,3	2,7	PRO21TC		10
	24,5×19,5	5,2	PRO25TC		8
	29×23,4	9	PRO30TC		8
	33×26,2	13	PRO35TC		8
	39×31,2	20	PRO40TC		5
	49×38,5	41	PRO50TC		5
	59×46,2	60	PRO60TC		5



Ø×H	C-CODE	EAN	
–	–	–	–
–	–	–	–
11,5×1,6	SPRO17TC		10
14,5×2,1	SPRO21TC		10
17,2×2,4	SPRO25TC		8
20,5×3	SPRO30TC		8
24,3×3,5	SPRO35TC		8
28×4	SPRO40TC		5
34,5×5	SPRO50TC		5
40,7×6	SPRO60TC		5



ROLLERS

GALETS ROULANTS / ROLLEN



COLOUR	CONTENT	L×W×H	C-CODE	EAN	
 black	6 pcs.	9,5×11×3,5	B6GR		10

Compatible with pots PRO30 to PRO80
 Compatibles avec les pots PRO30 à PRO80
 Passend für die Gefäße PRO30 bis PRO80





SQUARE PLANTER

BAC CARRÉ / BLUMENKÜBEL ECKIG



COLOUR	L×W×H	••• L	C-CODE	EAN	
granite	24×24×19,4	7	BRO25NV		8
	32×32×25,4	14	BRO32NV		8
	38,4×38,4×30,9	26	BRO39NV		5
taupe	24×24×19,4	7	BRO25TA		8
	32×32×25,4	14	BRO32TA		8
	38,4×38,4×30,9	26	BRO39TA		5
red morello	24×24×19,4	7	BRO25GT		8
	32×32×25,4	14	BRO32GT		8
	38,4×38,4×30,9	26	BRO39GT		5
khaki	24×24×19,4	7	BRO25KA		8
	32×32×25,4	14	BRO32KA		8
	38,4×38,4×30,9	26	BRO39KA		5
terracotta	24×24×19,4	7	BRO25TC		8
	32×32×25,4	14	BRO32TC		8
	38,4×38,4×30,9	26	BRO39TC		5

L×W×H	C-CODE	EAN	
17×17×2,5	SBRO25NV		8
22×22×3,2	SBRO32NV		8
27,6×27,6×3,8	SBRO39NV		5
17×17×2,5	SBRO25TA		8
22×22×3,2	SBRO32TA		8
27,6×27,6×3,8	SBRO39TA		5
17×17×2,5	SBRO25GT		8
22×22×3,2	SBRO32GT		8
27,6×27,6×3,8	SBRO39GT		5
17×17×2,5	SBRO25KA		8
22×22×3,2	SBRO32KA		8
27,6×27,6×3,8	SBRO39KA		5
17×17×2,5	SBRO25TC		8
22×22×3,2	SBRO32TC		8
27,6×27,6×3,8	SBRO39TC		5



ROLLERS

Compatible with pots BRO32 and BRO39
 Compatibles avec les bacs BRO32 et BRO39
 Passend für die Gefäße BRO32 und BRO39

P. / S. 55







02 EASY ROMÉO



WINDOW BOX

JARDINIÈRE / BLUMENKASTEN



COLOUR	L×W×H	••• L	C-CODE	EAN	
 granite	39,5×20,8×17	8	JRO40NV		10
	48,5×20,8×17	11	JRO50NV		10
	57,5×20,8×17	13	JRO60NV		10
	78×20,8×17	18	JRO80NV		5
 taupe	39,5×20,8×17	8	JRO40TA		10
	48,5×20,8×17	11	JRO50TA		10
	57,5×20,8×17	13	JRO60TA		10
	78×20,8×17	18	JRO80TA		5
 red morello	39,5×20,8×17	8	JRO40GT		10
	48,5×20,8×17	11	JRO50GT		10
	57,5×20,8×17	13	JRO60GT		10
 khaki	39,5×20,8×17	8	JRO40KA		10
	48,5×20,8×17	11	JRO50KA		10
	57,5×20,8×17	13	JRO60KA		10
	78×20,8×17	18	JRO80KA		5
 terracotta	39,5×20,8×17	8	JRO40TC		10
	48,5×20,8×17	11	JRO50TC		10
	57,5×20,8×17	13	JRO60TC		10
	78×20,8×17	18	JRO80TC		5

L×W×H	C-CODE	EAN	
35×15,5×3,3	SJRO40NV		10
43,6×15,5×3,3	SJRO50NV		10
53×16×3,3	SJRO60NV		10
73×16×3,3	SJRO80NV		5
35×15,5×3,3	SJRO40TA		10
43,6×15,5×3,3	SJRO50TA		10
53×16×3,3	SJRO60TA		10
73×16×3,3	SJRO80TA		5
35×15,5×3,3	SJRO40GT		10
43,6×15,5×3,3	SJRO50GT		10
53×16×3,3	SJRO60GT		10
35×15,5×3,3	SJRO40KA		10
43,6×15,5×3,3	SJRO50KA		10
53×16×3,3	SJRO60KA		10
73×16×3,3	SJRO80KA		5
35×15,5×3,3	SJRO40TC		10
43,6×15,5×3,3	SJRO50TC		10
53×16×3,3	SJRO60TC		10
73×16×3,3	SJRO80TC		5

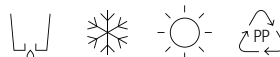





WINDOW BOX

JARDINIÈRE / BLUMENKASTEN



COLOUR	L×W×H	••• L	C-CODE	EAN	
 granite	48,5×20,8×17	11	JROSC50NV	3 167890 034847	8
	48,5×20,8×20,5	11	LT2JRO50NV	3 167894 031217	16 SET of 2
 taupe	48,5×20,8×17	11	JROSC50TA	3 167890 034823	8
	48,5×20,8×20,5	11	LT2JRO50TA	3 167894 131214	16 SET of 2
 red morello	48,5×20,8×17	11	JROSC50GT	3 167890 034830	8
	48,5×20,8×20,5	11	LT2JRO50GT	3 167894 331218	16 SET of 2
 khaki	48,5×20,8×17	11	JROSC50KA	3 167890 012296	8
	48,5×20,8×20,5	11	LT2JRO50KA	3 167890 012364	16 SET of 2
 sunflower	48,5×20,8×17	11	JROSC50TO	3 167890 012579	8

SET
of 2

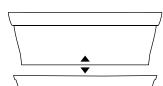

Includes clip-on tray
 Avec soucoupe clipsée
 Inkl. angeclipstem
 Untersetzer



























with support

WINDOW BOX + SUPPORT

JARDINIÈRE AVEC SUPPORT / BLUMENKASTEN MIT KASTENHALTER



COLOUR	L×W×H	••• L	C-CODE	EAN	
 granite	49×28×19	11	LTJRO50NVSUP	 3 167893 431209	15
	49×28×20,5	11	LT2JRO50NVSUP	 3 167891 531215	30 SET of 2
	49×28×22	11	LT3JRO50NVSUP	 3 167894 031206	21 SET of 3
 taupe	49×28×19	11	LTJRO50TASUP	 3 167893 531206	15
	49×28×20,5	11	LT2JRO50TASUP	 3 167891 631212	30 SET of 2
	49×28×22	11	LT3JRO50TASUP	 3 167894 131207	21 SET of 3
 red morello	49×28×19	11	LTJRO50GTSUP	 3 167899 731181	15
	49×28×20,5	11	LT2JRO50GTSUP	 3 167891 831216	30 SET of 2
	49×28×22	11	LT3JRO50GTSUP	 3 167899 831188	21 SET of 3
 khaki	49×28×19	11	LTJRO50KASUP	 3 167890 012371	15
	49×28×20,5	11	LT2JRO50KASUP	 3 167890 012388	30 SET of 2
	49×28×22	11	LT3JRO50KASUP	 3 167890 012395	21 SET of 3
 terracotta	49×28×19	11	LTJRO50TCSUP	 3 167893 331202	15
	49×28×22	11	LT3JRO50TCSUP	 3 167893 931204	21 SET of 3
 sunflower	49×28×19	11	LTJRO50TOSUP	 3 167890 039446	15

SET of 2

SET of 3

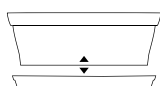

Includes clip-on tray
Avec soucoupe clipsée
Inkl. angeclipstem
Untersetzer

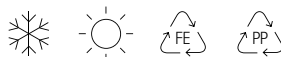



babyroméo



MINI WINDOW BOX

MINI JARDINIÈRE / BLUMENKASTEN MINI

COLOUR	L×W×H	••• L	C-CODE	EAN	
 granite	27,7×12,3×10,3	2	BBJRO28NV	3 167894 831206	10
 taupe	27,7×12,3×10,3	2	BBJRO28TA	3 167894 931203	10
 red morello	27,7×12,3×10,3	2	BBJRO28GT	3 167899 931185	10
 khaki	27,7×12,3×10,3	2	BBJRO28KA	3 167890 012258	10

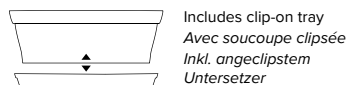

Includes clip-on tray
Avec soucoupe clipsée
Inkl. angeclipstem
Untersetzer



MINI WINDOW BOX + SUPPORT

MINI JARDINIÈRE AVEC SUPPORT / BLUMENKASTEN MINI MIT KASTENHALTER

COLOUR	L×W×H	••• L	C-CODE	EAN	
 granite	27,5×19×15	2	BBJRO28NVSUP	3 167895 531204	25
 taupe	27,5×19×15	2	BBJRO28TASUP	3 167895 631201	25
 red morello	27,5×19×15	2	BBJRO28GTSUP	3 167890 031198	25
 khaki	27,5×19×15	2	BBJRO28KASUP	3 167890 012265	25

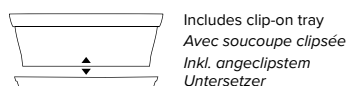

Includes clip-on tray
Avec soucoupe clipsée
Inkl. angeclipstem
Untersetzer

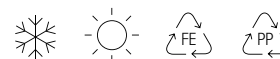



gran roméo

BIG WINDOW BOX

GRANDE JARDINIÈRE / BLUMENKASTEN GROSS



COLOUR	L×W×H	☼ L	C-CODE	EAN	
● granite	65,5×26,6×20,8	23	GJRO65NV	3 167897 831166	5
	77,7×26,6×20,8	28	GJRO78NV	3 167897 931163	5
● taupe	65,5×26,6×20,8	23	GJRO65TA	3 167899 431166	5
	77,7×26,6×20,8	28	GJRO78TA	3 167899 531163	5
● red morello	65,5×26,6×20,8	23	GJRO65GT	3 167894 231174	5
	77,7×26,6×20,8	28	GJRO78GT	3 167894 331171	5
● khaki	65,5×26,6×20,8	23	GJRO65KA	3 167890 012401	5
	77,7×26,6×20,8	28	GJRO78KA	3 167890 012418	5
● terracotta	65,5×26,6×20,8	23	GJRO65TC	3 167897 431175	5
	77,7×26,6×20,8	28	GJRO78TC	3 167897 531172	5

L×W×H	C-CODE	EAN	
59×20×4	SGJRO65NV	3 167898 031169	5
72×20×4	SGJRO78NV	3 167898 131166	5
59×20×4	SGJRO65TA	3 167899 631160	5
72×20×4	SGJRO78TA	3 167899 731167	5
59×20×4	SGJRO65GT	3 167894 431178	5
72×20×4	SGJRO78GT	3 167894 531175	5
59×20×4	SGJRO65KA	3 167890 012425	5
72×20×4	SGJRO78KA	3 167890 012432	5
59×20×4	SGJRO65TC	3 167897 631179	5
72×20×4	SGJRO78TC	3 167897 731176	5

Large planting volume capacity
Grand volume de plantation
Großes Pflanzvolumen





RECTANGULAR PLANTER

BAC RECTANGULAIRE / PFLANZTROG



COLOUR	L×W×H	••• L	C-CODE	EAN		L×W×H	C-CODE	EAN	
granite	78×38,4×35,3	66	BRRO80NV	3 167898 231163	5	67×28,5×4,6	SBRRO80NV	3 167898 431167	5
	98×38,4×35,3	85	BRRO100NV	3 167898 331160	5	87,5×28,5×4,6	SBRRO100NV	3 167898 531164	5
taupe	78×38,4×35,3	66	BRRO80TA	3 167899 831164	5	67×28,5×4,6	SBRRO80TA	3 167890 031174	5
	98×38,4×35,3	85	BRRO100TA	3 167899 931161	5	87,5×28,5×4,6	SBRRO100TA	3 167890 131171	5
red morello	78×38,4×35,3	66	BRRO80GT	3 167894 631172	5	67×28,5×4,6	SBRRO80GT	3 167894 831176	5
	98×38,4×35,3	85	BRRO100GT	3 167894 731179	5	87,5×28,5×4,6	SBRRO100GT	3 167894 931173	5
khaki	78×38,4×35,3	66	BRRO80KA	3 167890 012166	5	67×28,5×4,6	SBRRO80KA	3 167890 012180	5
	98×38,4×35,3	85	BRRO100KA	3 167890 012173	5	87,5×28,5×4,6	SBRRO100KA	3 167890 012197	5

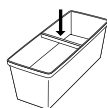

With reinforcement rod
Avec traverse de renfort
Mit Verstärkungsstrebe



**ROLLERS**

Also adaptable to the rectangular planters Roméo

Adaptés aux bacs rectangulaires Roméo

Auch passend für Roméo Pflanztröge

P./ S. 55

**HIGH RECTANGULAR PLANTER**

BAC RECTANGULAIRE HAUT / PFLANZTROG HOCH

COLOUR	L×W×H	● L	C-CODE	EAN	☰
granite	78×38,4×55,2	104	BRROP7855NV	3 1 67891 931206	3
taupe	78×38,4×55,2	104	BRROP7855TA	3 1 67892 031202	3
khaki	78×38,4×55,2	104	BRROP7855KA	3 1 67890 012241	3



L×W×H	C-CODE	EAN	☰
67×28,5×4,6	SBRRO80NV	3 1 67898 431167	5
67×28,5×4,6	SBRRO80TA	3 1 67890 031174	5
67×28,5×4,6	SBRRO80KA	3 1 67890 012180	5

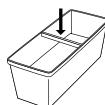

With reinforcement rod
Avec traverse de renfort
Mit Verstärkungsstrebe





COLUMN ROUND PLANTER

POT ROND HAUT / SÄULE RUND

COLOUR	Ø×H	•••L	C-CODE	EAN	
● granite	44×55,2	48	PROP4555NV		5
	53,7×67,5	70	PROP5567NV		3
● taupe	44×55,2	48	PROP4555TA		5
	53,7×67,5	70	PROP5567TA		3
● khaki	44×55,2	48	PROP4555KA		5
	53,7×67,5	70	PROP5567KA		3

Ø×H	C-CODE	EAN	
34,5×5	SPRO50NV		5
40,7×6	SPRO60NV		5
34,5×5	SPRO50TA		5
40,7×6	SPRO60TA		5
34,5×5	SPRO50KA		5
40,7×6	SPRO60KA		5



COLUMN SQUARE PLANTER

BAC CARRÉ HAUT / SÄULE ECKIG

COLOUR	L×W×H	•••L	C-CODE	EAN	
● granite	38,4×38,4×55,2	45	BROP3955NV		5
	46,9×46,9×67,5	60	BROP4767NV		3
● taupe	38,4×38,4×55,2	45	BROP3955TA		5
	46,9×46,9×67,5	60	BROP4767TA		3
● khaki	38,4×38,4×55,2	45	BROP3955KA		5
	46,9×46,9×67,5	60	BROP4767KA		3

L×W×H	C-CODE	EAN	
27,6×27,6×3,8	SBRO39NV		5
33,5×33,5×4	SBRO47NV		3
27,6×27,6×3,8	SBRO39TA		5
33,5×33,5×4	SBRO47TA		3
27,6×27,6×3,8	SBRO39KA		5
33,5×33,5×4	SBRO47KA		3















02 EASY ROMÉO ROTOMOULDED



ROUND PLANTER XXL

POT ROND XXL / XXL BLUMENKÜBEL RUND

COLOUR	Ø×H	••• L	C-CODE	EAN	
anthracite	78×71	185	PROR80NV	 3 167890 003447	1
	98×88	380	PROR100NV	 3 167890 003478	1
	117×92	550	PROR120NV	 3 167890 006516	1
taupe	78×71	185	PROR80TA	 3 167890 003454	1
	98×88	380	PROR100TA	 3 167890 003485	1
	117×92	550	PROR120TA	 3 167890 006530	1
red morello	78×71	185	PROR80GT	 3 167890 003461	1
	98×88	380	PROR100GT	 3 167890 003492	1
	117×92	550	PROR120GT	 3 167890 006509	1



Rotomoulded – high thickness and very resistant.
Suitable for planting trees and shrubs.

Fabriqués en rotomoulage, ces pots Roméo XXL sont ultra résistants grâce à leur forte épaisseur. Ils conviennent à la plantation d'arbres et arbustes.

Rotationsgeformt – extrem widerstandsfähig durch eine sehr hohe Materialdicke. Geeignet für kleine Bäume und Sträucher.

02 EASY PAPHYRUS



ROUND PLANTER

POT ROND / BLUMENKÜBEL RUND



COLOUR	Ø×H	∅ L	L	C-CODE	EAN	
taupe	24,5×19,5	4,6	0,6	PAR25TA	3 167894 831138	6
	29×23,4	8,2	0,8	PAR30TA	3 167895 231135	6
	33×26,2	12	1	PAR35TA	3 167895 631133	6
	39×31,2	17,9	2,1	PAR40TA	3 167896 031130	6
	49×38,5	38	3	PAR50TA	3 167896 431138	4
black	24,5×19,5	4,6	0,6	PAR25N	3 167894 631134	6
	29×23,4	8,2	0,8	PAR30N	3 167895 031131	6
	33×26,2	12	1	PAR35N	3 167895 431133	6
	39×31,2	17,9	2,1	PAR40N	3 167895 831137	6
	49×38,5	38	3	PAR50N	3 167896 231134	4
red	24,5×19,5	4,6	0,6	PAR25R	3 167894 731131	6
	29×23,4	8,2	0,8	PAR30R	3 167895 131138	6
	33×26,2	12	1	PAR35R	3 167895 531136	6
	39×31,2	17,9	2,1	PAR40R	3 167895 931134	6
	49×38,5	38	3	PAR50R	3 167896 331131	4

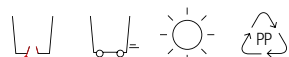

SQUARE PLANTER

BAC CARRÉ / BLUMENKÜBEL ECKIG



COLOUR	L×W×H	∅ L	L	C-CODE	EAN	
taupe	24×24×19,4	6,2	0,8	PAC25TA	3 167896 831136	6
	32×32×25,4	12,8	1,2	PAC32TA	3 167897 231133	6
	38,4×38,4×30,9	23,2	2,8	PAC39TA	3 167897 631131	4
black	24×24×19,4	6,2	0,8	PAC25N	3 167896 631132	6
	32×32×25,4	12,8	1,2	PAC32N	3 167897 031139	6
	38,4×38,4×30,9	23,2	2,8	PAC39N	3 167897 431137	4
red	24×24×19,4	6,2	0,8	PAC25R	3 167896 731139	6
	32×32×25,4	12,8	1,2	PAC32R	3 167897 131136	6
	38,4×38,4×30,9	23,2	2,8	PAC39R	3 167897 531134	4

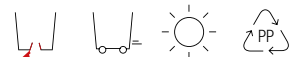

ROLLERS

Compatible with pots PAR30 to PAR50, PAC32 and PAC39
 Compatibles avec les bacs PAR30 à PAR50, PAC32 et PAC39
 Passend für die Gefäße PAR30 bis PAR50, PAC32 und PAC39
P./S. 55



papyrus



ROUND HIGH COLUMN PLANTER

POT ROND HAUT / HOHE SÄULE RUND

COLOUR	Ø×H	••• L	• L	C-CODE	EAN	
taupe	44 × 55,2	41,7	4,3	PAR4555TA	3 167892 231145	3
black	44 × 55,2	41,7	4,3	PAR4555N	3 167892 031141	3



Water tank with visible water level
Réserve d'eau avec niveau d'eau visible
Wasserstandsanzeige

Overflow with cap to prevent overwatering
Trop plein avec bouchon pour éviter les excès d'arrosage
Überlauf mit Verschluss zum Verhindern von Überwässerung



SQUARE HIGH COLUMN PLANTER

BAC CARRÉ HAUT / HOHE SÄULE ECKIG

COLOUR	L×W×H	••• L	• L	C-CODE	EAN	
taupe	38,4 × 38,4 × 55,2	44	4	PAC3955TA	3 167892 731140	3
black	38,4 × 38,4 × 55,2	44	4	PAC3955N	3 167892 531146	3





With its special grain, which gives it a natural matt appearance, and its soft, harmonious curve, Lilo fits in with a warm decorative style. The Lilo pot is suitable for both indoor and outdoor use thanks to its drilled base with a tight-fitting cap.

Avec son grain particulier qui lui procure un aspect mat naturel et sa courbe douce et harmonieuse, LILO s'inscrit dans un style de décoration chaleureux. Le pot Lilo convient aussi bien en intérieur qu'en extérieur grâce à son fond percé avec bouchon étanche.

Mit seiner besonderen Maserung, die ihm ein natürlich mattes Aussehen verleiht, und seinem weichen und harmonischen Schwung ist LILO Teil eines warmen Einrichtungsstils. Der Lilo-Topf ist dank seines durchbohrten Bodens mit wasserdichter Kappe sowohl für den Innen- als auch Außenbereich geeignet.

lilo

ROUND PLANTER
POT ROND / BLUMENKÜBEL RUND



COLOUR	Ø×H	L	C-CODE	EAN	
limestone	16×15,2	2	PLR16CAL	3 167890 002242	12
	20×19	3,9	PLR20CAL	3 167890 002297	12
	24,8×23,5	7,5	PLR24CAL	3 167890 002365	6
	28,8×27	11,7	PLR28CAL	3 167890 002419	6
	34,9×33	20,8	PLR34CAL	3 167890 002464	6
slate	16×15,2	2	PLR16AR	3 167890 002266	12
	20×19	3,9	PLR20AR	3 167890 002334	12
	24,8×23,5	7,5	PLR24AR	3 167890 002389	6
	28,8×27	11,7	PLR28AR	3 167890 002433	6
	34,9×33	20,8	PLR34AR	3 167890 002488	6
graphite	16×15,2	2	PLR16GP	3 167890 002235	12
	20×19	3,9	PLR20GP	3 167890 002280	12
	24,8×23,5	7,5	PLR24GP	3 167890 002358	6
	28,8×27	11,7	PLR28GP	3 167890 002402	6
	34,9×33	20,8	PLR34GP	3 167890 002457	6
concrete	16×15,2	2	PLR16BT	3 167890 002228	12
	20×19	3,9	PLR20BT	3 167890 002273	12
	24,8×23,5	7,5	PLR24BT	3 167890 002341	6
	28,8×27	11,7	PLR28BT	3 167890 002396	6
	34,9×33	20,8	PLR34BT	3 167890 002440	6

Ø×H	C-CODE	EAN	
13,8×2,9	SPLR16CAL	3 167890 002518	12
16×3,1	SPLR20CAL	3 167890 002563	12
20×3,6	SPLR24CAL	3 167890 002617	6
25×4,1	SPLR28CAL	3 167890 002662	6
27,5×4,4	SPLR34CAL	3 167890 002716	6
13,8×2,9	SPLR16AR	3 167890 002532	12
16×3,1	SPLR20AR	3 167890 002587	12
20×3,6	SPLR24AR	3 167890 002631	6
25×4,1	SPLR28AR	3 167890 002686	6
27,5×4,4	SPLR34AR	3 167890 002730	6
13,8×2,9	SPLR16GP	3 167890 002501	12
16×3,1	SPLR20GP	3 167890 002556	12
20×3,6	SPLR24GP	3 167890 002600	6
25×4,1	SPLR28GP	3 167890 002655	6
27,5×4,4	SPLR34GP	3 167890 002709	6
13,8×2,9	SPLR16BT	3 167890 002495	12
16×3,1	SPLR20BT	3 167890 002549	12
20×3,6	SPLR24BT	3 167890 002594	6
25×4,1	SPLR28BT	3 167890 002648	6
27,5×4,4	SPLR34BT	3 167890 002693	6

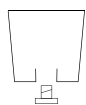

Stopper for indoor and outdoor use
Bouchon pour une utilisation intérieure
et extérieure
Verschlusskappe für die Nutzung
innen und außen



02 EASY LUNE

Lune



New
colours



A simple and round design for a decoration full of softness.









Un design simple, tout en rondeur pour une déco pleine de douceur.

Ein schlichtes rundes Design für eine moderne Raumgestaltung.

ROUND CUP PLANTER

COUPE / BLUMENSCHALE RUND



COLOUR	Ø×H	•••L	C-CODE	EAN	
 white	24×18	6,5	CLU25BC	 3 1 67899 131202	4
 granite	24×18	6,5	CLU25NV	 3 1 67898 931209	4
 blue jean	24×18	6,5	CLU25BJ	 3 1 67890 039408	4
 khaki	24×18	6,5	CLU25KA	 3 1 67890 039415	4











Clip-on saucer – flat base for stability
 Soucoupe clipsée – base plate pour une bonne stabilité
 Inkl. angeclipstem Untersetzer – flacher Boden für Stabilität



HANGING PLANTER

SUSPENSION / HÄNGESCHALE



COLOUR	Ø×H	•••L	C-CODE	EAN	
 white	24×18	6,5	SLU25BC	 3 1 67898 0731205	4
 granite	24×18	6,5	SLU25NV	 3 1 67898 0531201	4
 blue jean	24×18	6,5	SLU25BJ	 3 1 67890 039422	4
 khaki	24×18	6,5	SLU25KA	 3 1 67890 039439	4

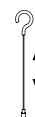

45 – 70 cm
 Cable with adjustable height
 Câble avec hauteur réglable
 Hängeschnur in der Höhe verstellbar



cute country





The Landhaus range, recognisable among many others thanks to its unique design, and made of recycled material, creates a friendly atmosphere and invites to relax in the garden.

Reconnaissable parmi tant d'autres, grâce à son design unique, la gamme Landhaus, fabriquée en matière recyclée, crée une atmosphère conviviale et invite à la détente au jardin.

Das Landhaus-Sortiment, welches dank seines einzigartigen Designs unter vielen anderen hervorsteht und aus recyceltem Material besteht, schafft eine freundliche Atmosphäre und lädt zum Entspannen im Garten ein.



ORIGINAL Landhaus



Integrated watering kit with level indicator and filling chamber

Kit d'irrigation avec indicateur de niveau d'eau et entonnoir









Integriertes Bewässerungs-Kit mit Wasserstandsanzeige inkl. Füllschacht



WINDOW BOX

JARDINIÈRE / BLUMENKASTEN



COLOUR	L×W×H	•• L	L	C-CODE	EAN	
 yellow	46,6×19,8×15,8	8	1,5	JLHAC50J	3 1 6 7 8 9 0 0 1 7 6 0 4	5
	74×19,8×15,8	13	2,5	JLHAC75J	3 1 6 7 8 9 0 0 1 7 6 8 0	5
 green	46,6×19,8×15,8	8	1,5	JLHAC50AN	3 1 6 7 8 9 0 0 1 7 6 1 1	5
	74×19,8×15,8	13	2,5	JLHAC75AN	3 1 6 7 8 9 0 0 1 7 6 9 7	5
	99×19,8×15,8	17	3,5	JLHAC100AN	3 1 6 7 8 9 0 0 1 7 7 6 5	5
 granite	46,6×19,8×15,8	8	1,5	JLHAC50GRA	3 1 6 7 8 9 0 0 1 7 6 2 8	5
	74×19,8×15,8	13	2,5	JLHAC75GRA	3 1 6 7 8 9 0 0 1 7 7 0 3	5
	99×19,8×15,8	17	3,5	JLHAC100GRA	3 1 6 7 8 9 0 0 1 7 7 7 2	5
 silk grey	46,6×19,8×15,8	8	1,5	JLHAC50GS	3 1 6 7 8 9 0 0 1 7 6 3 5	5
	74×19,8×15,8	13	2,5	JLHAC75GS	3 1 6 7 8 9 0 0 1 7 7 1 0	5
	99×19,8×15,8	17	3,5	JLHAC100GS	3 1 6 7 8 9 0 0 1 7 7 8 9	5
 white	46,6×19,8×15,8	8	1,5	JLHAC50BL	3 1 6 7 8 9 0 0 1 7 6 4 2	5
	74×19,8×15,8	13	2,5	JLHAC75BL	3 1 6 7 8 9 0 0 1 7 7 2 7	5
	99×19,8×15,8	17	3,5	JLHAC100BL	3 1 6 7 8 9 0 0 1 7 7 9 6	5
 laurel green	46,6×19,8×15,8	8	1,5	JLHAC50VL	3 1 6 7 8 9 0 0 1 7 6 5 9	5
	74×19,8×15,8	13	2,5	JLHAC75VL	3 1 6 7 8 9 0 0 1 7 7 3 4	5
 red violet	46,6×19,8×15,8	8	1,5	JLHAC50FR	3 1 6 7 8 9 0 0 1 7 6 7 3	5
	74×19,8×15,8	13	2,5	JLHAC75FR	3 1 6 7 8 9 0 0 1 7 7 5 8	5

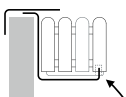



Concealed mount for window box brackets
Dispositif de fixation invisible pour support de jardinière
Verdeckte Aufnahme für Blumenkastenhalterung



METAL BRACKETS

SUPPORTS / BLUMENKASTENHALTER



COLOUR	C-CODE	EAN	
 white	SUPJLHBL	3 1 6 7 8 9 0 0 1 4 8 7 0	10
 aluminium	SUPJLHAL	3 1 6 7 8 9 0 0 1 4 8 8 7	10



1/1 DISPLAY 120x80x105

1/1 PRÉSENTOIR GARNI / 1/1 DISPLAY BESTÜCKT

C-CODE	EAN	
BOX880	3 1 6 7 8 9 0 0 1 7 8 2 6	1

35×Window boxes 75 cm / Jardinières 75 cm
Blumenkästen 75 cm

 5  5  5  15

C-CODE	EAN	
BOX879	3 1 6 7 8 9 0 0 1 7 8 1 9	1

55×Window boxes 50 cm / Jardinières 50 cm
Blumenkästen 50 cm

 10  5  5  5  30

C-CODE	EAN	
BOX878	3 1 6 7 8 9 0 0 1 7 8 0 2	1

20×Window boxes 50 cm + 20×Window boxes 75 cm
Jardinières 50 cm + 75 cm / Blumenkästen 50 cm + 75 cm

 5  5  10 +  5  5  10

PLANTER BASKET

PANIER / KÖRBCHEN



COLOUR	L×W×H	•••L	C-CODE	EAN	
yellow	28,6×18×14,5	3,5	PALH28J	3 167890 014412	5
green	28,6×18×14,5	3,5	PALH28AN	3 167890 014429	5
silk grey	28,6×18×14,5	3,5	PALH28GS	3 167890 014436	5
white	28,6×18×14,5	3,5	PALH28BL	3 167890 014443	5
laurel green	28,6×18×14,5	3,5	PALH28VL	3 167890 014467	5
red violet	28,6×18×14,5	3,5	PALH28FR	3 167890 014481	5

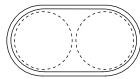

For 2 x 12 cm
Perfect for 2×12 cm pot
Idéal pour 2 pots de culture de 12 cm
Perfekt für 2×12er Kulturtopf



PLANTER TON

POT À SUSPENDRE / FÄSSCHEN



COLOUR	Ø×H	•••L	C-CODE	EAN	
yellow	15,5×22,1	1,4	PSULH15J	3 167890 014498	5
green	15,5×22,1	1,4	PSULH15AN	3 167890 014504	5
silk grey	15,5×22,1	1,4	PSULH15GS	3 167890 014511	5
white	15,5×22,1	1,4	PSULH15BL	3 167890 014528	5
laurel green	15,5×22,1	1,4	PSULH15VL	3 167890 014542	5
red violet	15,5×22,1	1,4	PSULH15FR	3 167890 014566	5



For 1 x 12 cm
Perfect for 1×12 cm pot
Idéal pour un pot de culture de 12 cm
Perfekt für 1×12er Kulturtopf

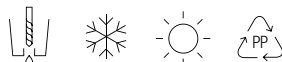

ACCESSORY HOOKS BIG

CROCHETS POUR ACCESSOIRES / ZUBEHÖRHAKEN

COLOUR	CONTENT	CM	C-CODE	EAN	
aluminium	3 pcs.	11×7	3CRO6AL	3 167890 013507	10

max. 6 cm

18/10
STEEL













100% recycled 



JARDINIÈRE

JARDINIÈRE / JARDINIÈRE



COLOUR	L×W×H	••• L	C-CODE	EAN	
 yellow	38,9×14,8×19,1	4,3	JLH40J	 3 167890 014697	5
 green	38,9×14,8×19,1	4,3	JLH40AN	 3 167890 014603	5
 silk grey	38,9×14,8×19,1	4,3	JLH40GS	 3 167890 014610	5
 white	38,9×14,8×19,1	4,3	JLH40BL	 3 167890 014627	5
 laurel green	38,9×14,8×19,1	4,3	JLH40VL	 3 167890 014641	5
 red violet	38,9×14,8×19,1	4,3	JLH40FR	 3 167890 014665	5

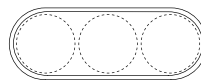

For 3 x 12 cm
Perfect for 3 x 12 cm pot
Idéal pour 3 pots de culture de 12 cm
Perfekt für 3x12er Kulturtopf



RAILING POT

POT POUR BALUSTRADE / GELÄNDERTOPF



COLOUR	L×W×H	••• L	C-CODE	EAN	
 green	29,5×29,5×26,5	9,2	PBLH30AN	 3 167890 014962	5
 granite	29,5×29,5×26,5	9,2	PBLH30GRA	 3 167890 014979	5
 silk grey	29,5×29,5×26,5	9,2	PBLH30GS	 3 167890 014986	5
 white	29,5×29,5×26,5	9,2	PBLH30BL	 3 167890 014993	5

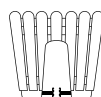

Max. 6 cm Ø
With fixing screw
Avec vis de fixation
Mit Fixierschraube



02 EASY LANDHAUS BIRDWORLD

ORIGINAL
Landhaus

tiny
**bird
homes**

100% recycled 



Perfect for small songbirds:
3 cm opening. Developed in
cooperation with ornithologists.
Reliable protection, especially
in wet weather.









Ouverture de 3 cm de diamètre :
idéale pour les petits oiseaux
chanteurs. Ce produit a été conçu
avec des ornithologues. Une
protection efficace, notamment
par temps humide.

Ideal für viele Kleinsingvögel:
Mit 3 cm Öffnung. Mit Ornithologen
entwickelt. Zuverlässiger Schutz,
besonders bei feuchter Witterung.

BIRD HOUSE

NICHOIR / NISTKASTEN



COLOUR	L×W×H	C-CODE	EAN	
 white / granite	15×15,9×23,5	NLHBLGRA	 3 1 6 7 8 9 0 0 1 5 1 2 9	4
 white / green	15×15,9×23,5	NLHBLAN	 3 1 6 7 8 9 0 0 1 5 1 3 6	4
 white / antique blue	15×15,9×23,5	NLHBLBLP	 3 1 6 7 8 9 0 0 1 5 1 4 3	4
 silk grey	15×15,9×23,5	NLHGS	 3 1 6 7 8 9 0 0 1 5 1 5 0	4



Double base for optimum
ventilation. Remarkably hygienic:
easy and thorough cleaning.

Double base pour une aération
optimale. Nettoyage facile.

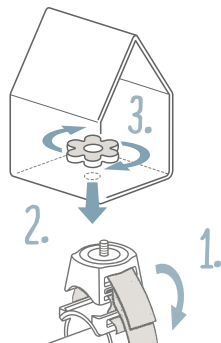

Doppelter Boden für optimale
Belüftung. Besonders hygienisch:
leichte und gründliche Reinigung.



RAILING HOLDER

ACCROCHE POUR BALUSTRADE / GELÄNDERHALTERUNG



COLOUR	L×W×H	C-CODE	EAN	
 anthracite	9×5×12	FXBNLHANT	 3 1 6 7 8 9 0 0 1 5 2 2 8	10

For

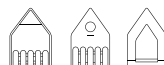

18/10
STEEL



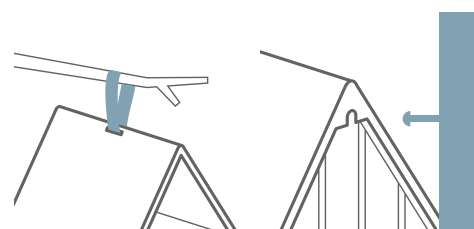

All LANDHAUS bird products can be hung or mounted on the wall. You will find another practical mounting option on page 81.

Tous les produits pour oiseaux LANDHAUS peuvent être suspendus ou fixés sur un mur. Vous trouverez une autre option de montage pratique à la page 81.

Alle LANDHAUS Vogelprodukte können freihängend oder an der Wand montiert werden. Eine weitere praktische Anbringungsmöglichkeit finden Sie auf Seite 81.



BIRD FEEDER

MANGEOIRE À OISEAUX / FUTTERHAUS

COLOUR	L×W×H	C-CODE	EAN	
 granite	13,7×14,6×20,6	MLHGRA	 3 1 6 7 8 9 0 0 1 5 0 7 5	4
 green	13,7×14,6×20,6	MLHAN	 3 1 6 7 8 9 0 0 1 5 0 8 2	4
 antique blue	13,7×14,6×20,6	MLHBLP	 3 1 6 7 8 9 0 0 1 5 0 9 9	4
 laurel green	13,7×14,6×20,6	MLHVL	 3 1 6 7 8 9 0 0 1 5 1 0 5	4
 smoky brown	13,7×14,6×20,6	MLHMK	 3 1 6 7 8 9 0 0 1 5 1 1 2	4





BIRD FEED DISPENSER

DISTRIBUTEUR DE GRAINES / FUTTERSILO

COLOUR	L×W×H	C-CODE	EAN	
 granite	15,4×10×23,4	DGLHGRA		4
 white/granite	15,4×10×23,4	DGLHBLGRA		4
 green	15,4×10×23,4	DGLHAN		4
 antique blue	15,4×10×23,4	DGLHBLP		4
 laurel green	15,4×10×23,4	DGLHVL		4

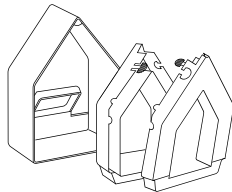

Filling level is clearly visible at all times.
Quick to fill and clean.

*Niveau de remplissage visible.
Remplissage et nettoyage rapides.*

*Der Füllstand ist jederzeit klar im Blick.
Schnell aufzufüllen und zu reinigen.*

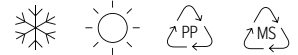



* Does not apply to the transparent part of the bird feed dispenser | Pas la partie transparente du distributeur d'aliments pour oiseaux | Gilt nicht für den transparenten Teil des Futtersilos



1/4 DISPLAY EQUIPPED

1/4 PRÉSENTOIR GARNI / 1/4 DISPLAY BESTÜCKT

L×W×H	C-CODE	EAN	
60×40×154	BOX888		1

12 × Bird feeder / Mangeoires / Futterhaus

 4  4  4

16 × Bird feed dispenser / Distributeurs de graines / Futtersilo

 4  4  4  4

8 × Bird house / Nichoir / Nistkästen

 4  4

10 × Railing holder / Accroche pour balustrade / Geländerhalterung



1/4 DISPLAY EQUIPPED

1/4 PRÉSENTOIR GARNI / 1/4 DISPLAY BESTÜCKT

L×W×H	C-CODE	EAN	
60×40×154	BOX887		1

12 × Bird feeder / Mangeoires / Futterhaus

 4  4  4

28 × Bird feed dispenser / Distributeurs de graines / Futtersilo

 4  12  4  4  4

10 × Railing holder / Accroche pour balustrade / Geländerhalterung

FRESH HERBS

Fresh herbs close to hand!

Des herbes fraîches à portée de main !

Frische Kräuter schnell zur Hand!





Self-watering
Irrigation automatique
Selbstbewässerung

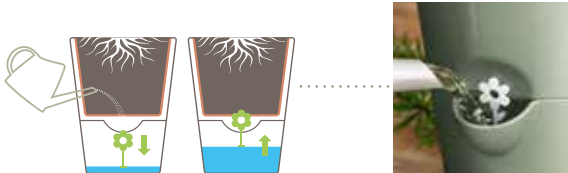

Besides perfect functionality,
the clever waterlevel flower
makes the herb pot an ideal
impulse and gift item

*Un indicateur de niveau d'eau
fonctionnel et original qui fait
de ce produit un achat coup
de coeur*

*Neben perfekter Funktion
macht die originelle
Wasserstand-Blume den
Kräutertopf zum idealen
Impuls- und Geschenkartikel*

No direct planting – The wick is directly
turned in the pot

*Pas de plantation directe : la mèche est
enroulée directement dans le pot
de culture*

*Keine Direktbepflanzung – Docht wird
direkt in den Kulturtopf gedreht*



HERB POT

POT POUR AROMATIQUES / KRÄUTERTOPF

COLOUR	Ø×H	•••L	•L	C-CODE	EAN	
white	14×18	1,2	0,5	PFH13BL	3 1 67890 012609	4
granite	14×18	1,2	0,5	PFH13GRA	3 1 67890 012616	4
green	14×18	1,2	0,5	PFH13V	3 1 67890 012623	4
sage	14×18	1,2	0,5	PFH13SA	3 1 67890 012654	4
silk grey	14×18	1,2	0,5	PFH13GS	3 1 67890 012630	4
sepia rose	14×18	1,2	0,5	PFH13RS	3 1 67890 012647	4



For 1 x 12 cm
Perfect for 1×12 cm pot
Idéal pour un pot de culture de 12 cm
Perfekt für 1×12er Kulturtopf

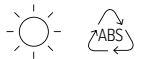

HERB POT TRIO

POT TRIO POUR AROMATIQUES / TRIO KRÄUTERTOPF

COLOUR	L×W×H	•••L	•L	C-CODE	EAN	
white	27×25×21	3×1L	0,9	P3FH13BL	3 1 67890 012661	2
green	27×25×21	3×1L	0,9	P3FH13V	3 1 67890 012678	2

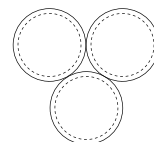

For 3 x 12 cm
Perfect for 3×12 cm pot
Idéal pour 3 pots de culture de 12 cm
Perfekt für 3×12er Kulturtopf

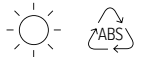

WATERING SET

KIT D'IRRIGATION / BEWÄSSERUNGSSET

CONTENT	L×W×H	C-CODE	EAN	
9 pcs.	6×9×3	KITIRFH	3 1 67890 035011	10

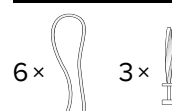

basic garden



Practical and clever products to make all your gardening projects a success.
Decorating and landscaping has never been so easy!

*Des produits pratiques et astucieux pour réussir tous ses projets de jardinage.
Décorer et aménager ses extérieurs n'auront jamais été aussi simple !*

*Praktische und clevere Produkte garantieren den Erfolg Ihrer Gartenprojekte.
Dekoration und Gartengestaltung war noch nie so einfach!*







MY CITY GARDEN

**SPECIAL for Casa Mesh & My City Garden**

Matching brackets

*Supports de jardinière assorties**Der passende Kastenhalter***P./S. 139****WINDOW BOX**

JARDINIÈRE / BLUMENKASTEN

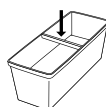

COLOUR	L×W×H	•••L	•L	C-CODE	EAN	☰
granite	50×20×18	10	2,5	JMCGRE50GRA	3 167890 013750	5
	75×20×18	15,6	4	JMCGRE75GRA	3 167890 013767	5
terracotta	50×20×18	10	2,5	JMCGRE50TC	3 167890 013774	5
	75×20×18	15,6	4	JMCGRE75TC	3 167890 013781	5
white	50×20×18	10	2,5	JMCGRE50BL	3 167890 013712	5
	75×20×18	15,6	4	JMCGRE75BL	3 167890 013729	5
green	50×20×18	10	2,5	JMCGRE50AN	3 167890 013798	5
	75×20×18	15,6	4	JMCGRE75AN	3 167890 013804	5
dusty grey	50×20×18	10	2,5	JMCGRE50GC	3 167890 013736	5
	75×20×18	15,6	4	JMCGRE75GC	3 167890 013743	5

**75 cm**With reinforcement rod
Avec traverse de renfort
Mit Verstärkungsstrebe**RAILING POT**

POT BALUSTRADE / GELÄNDERTOPF

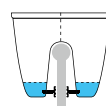

COLOUR	L×W×H	•••L	•L	C-CODE	EAN	☰
granite	29,6×29,6×26,2	9	0,6	PBMCG30GRA	3 167890 013651	5
	59,8×29,6×26,2	21	1,8	JBMCG60GRA	3 167890 013668	5
taupe	29,6×29,6×26,2	9	0,6	PBMCG30TA	3 167890 042675	5
	59,8×29,6×26,2	21	1,8	JBMCG60TA	3 167890 042668	5
terracotta	29,6×29,6×26,2	9	0,6	PBMCG30TC	3 167890 013699	5
	59,8×29,6×26,2	21	1,8	JBMCG60TC	3 167890 013705	5
white	29,6×29,6×26,2	9	0,6	PBMCG30BL	3 167890 013613	5
	59,8×29,6×26,2	21	1,8	JBMCG60BL	3 167890 013620	5
green	29,6×29,6×26,2	9	0,6	PBMCG30AN	3 167890 013675	5
	59,8×29,6×26,2	21	1,8	JBMCG60AN	3 167890 013682	5
dusty grey	29,6×29,6×26,2	9	0,6	PBMCG30GC	3 167890 013637	5
	59,8×29,6×26,2	21	1,8	JBMCG60GC	3 167890 013644	5

**New
colour**With fixing screw.
Remains stable, even
during stormy weather*Avec vis de fixation.*
Reste stable, même en
*cas d'intempéries**Mit Fixierschraube.*
Bleibt stabil, auch bei
schlechtem WetterLarge planting volume
also in the centre part*Grande profondeur de plantation*
*même dans la partie centrale**Großes Pflanzvolumen auch im Mittelteil*





Anthracite metal bracket
Support métallique anthracite
Metallhalterung in anthrazit

Locking clip
Clip de sécurité
Sicherungsclip

Plastic buffer for scratch-prone surfaces

Butoir en plastique pour les surfaces facilement rayables

Kunststoff-Puffer für empfindliche Oberflächen

Clip-on tray
Soucoupe clipsée
Angeclipster Untersetzer

HANGING PLANTER

POT POUR BALUSTRADE / HÄNGETOPF



COLOUR	L×W×H	•••L	C-CODE	EAN	
 granite	20,2×25,9×17,6	2,5	PMCG20GRASCSUP	 3 167890 013552	8
 terracotta	20,2×25,9×17,6	2,5	PMCG20TCSCSUP	 3 167890 013590	8
 white	20,2×25,9×17,6	2,5	PMCG20BLSCSUP	 3 167890 013514	8
 green	20,2×25,9×17,6	2,5	PMCG20ANSCSUP	 3 167890 013576	8



HANGING PLANTER

JARDINIÈRE POUR BALUSTRADE / HÄNGETOPF



COLOUR	L×W×H	•••L	C-CODE	EAN	
 granite	40,2×26,1×17,6	7	JMCG40GRASCSUP	 3 167890 013569	4
 terracotta	40,2×26,1×17,6	7	JMCG40TCSCSUP	 3 167890 013606	4
 white	40,2×26,1×17,6	7	JMCG40BLSCSUP	 3 167890 013521	4
 green	40,2×26,1×17,6	7	JMCG40ANSCSUP	 3 167890 013583	4







ROUND PLANTER

POT ROND / BLUMENKÜBEL RUND



COLOUR	Ø×H	••• L	C-CODE	EAN	
granite	24,6×19,7	5	PMCG25GRA	3 167890 013033	10
	29,6×23,9	9	PMCG30GRA	3 167890 013040	10
	39,6×31,4	20	PMCG40GRA	3 167890 013057	10
	49,6×39,2	40	PMCG50GRA	3 167890 013064	5
terracotta	24,6×19,7	5	PMCG25TC	3 167890 013071	10
	29,6×23,9	9	PMCG30TC	3 167890 013088	10
	39,6×31,4	20	PMCG40TC	3 167890 013095	10
	49,6×39,2	40	PMCG50TC	3 167890 013101	5

Ø×H	C-CODE	EAN	
20,5×3	SPMCG21GRA	3 167890 013156	10
24,6×3,6	SPMCG25GRA	3 167890 013163	10
32,7×4,7	SPMCG33GRA	3 167890 013170	10
40,9×5,9	SPMCG41GRA	3 167890 013187	10
20,5×3	SPMCG21TC	3 167890 013194	10
24,6×3,6	SPMCG25TC	3 167890 013200	10
32,7×4,7	SPMCG33TC	3 167890 013217	10
40,9×5,9	SPMCG41TC	3 167890 013224	10



SQUARE PLANTER

BAC CARRÉ / BLUMENKÜBEL ECKIG



COLOUR	L×W×H	••• L	C-CODE	EAN	
granite	29,6×29,6×25,6	13	BMCG30GRA	3 167890 012722	10
	34×34×30	20	BMCG35GRA	3 167890 012739	10
	39,6×39,6×34,2	30	BMCG40GRA	3 167890 012746	10
terracotta	29,6×29,6×25,6	13	BMCG30TC	3 167890 012753	10
	34×34×30	20	BMCG35TC	3 167890 012760	10
	39,6×39,6×34,2	30	BMCG40TC	3 167890 012777	10

L×W×H	C-CODE	EAN	
24,6×24,6×3,6	SBMCG25GRA	3 167890 012814	10
28,6×28,6×4	SBMCG29GRA	3 167890 012821	10
32,9×32,9×4,8	SBMCG33GRA	3 167890 012838	10
24,6×24,6×3,6	SBMCG25TC	3 167890 012845	10
28,6×28,6×4	SBMCG29TC	3 167890 012852	10
32,9×32,9×4,8	SBMCG33TC	3 167890 012869	10



RECTANGULAR PLANTER

JARDINIÈRE / PFLANZTROG



COLOUR	L×W×H	••• L	C-CODE	EAN	
granite	59,6×29,6×25,6	30	JMCG60GRA	3 167890 012890	10
	78,5×34×30	60	JMCG80GRA	3 167890 012906	5
terracotta	59,6×29,6×25,6	30	JMCG60TC	3 167890 012913	10
	78,5×34×30	60	JMCG80TC	3 167890 012920	5

L×W×H	C-CODE	EAN	
54,4×24,6×3,6	SJMCG5525GRA	3 167890 012951	10
73,6×28,6×4	SJMCG7429GRA	3 167890 012968	10
54,4×24,6×3,6	SJMCG5525TC	3 167890 012975	10
73,6×28,6×4	SJMCG7429TC	3 167890 012982	10

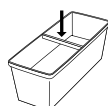

With reinforcement rod
Avec traverse de renfort
Mit Verstärkungsstrebe



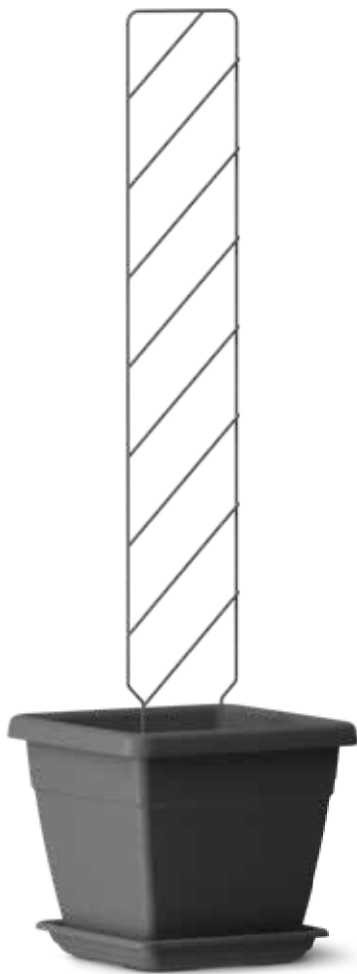

TRELLIS SHORT

TRELLIS / RANKGITTER KURZ



COLOUR	L×W×H	C-CODE	EAN	
anthracite	18,5×92,1×0,6	TSMCG92ANT	3 1 67890 013231	5



Ideal for planters from size 30 cm
Convient parfaitement pour les pots à partir de 30 cm
 Passend für Töpfe ab 30 cm



TRELLIS LONG

TRELLIS / RANKGITTER LANG



COLOUR	L×W×H	C-CODE	EAN	
anthracite	18,8×118,5×0,6	TSMCG118ANT	3 1 67890 013255	5



Ideal for planters from size 40 cm
Convient parfaitement pour les pots à partir de 40 cm
 Passend für Töpfe ab 40 cm



TRELLIS SET

TRELLIS SET / RANKGITTER SET

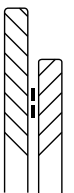

COLOUR	L×W×H	C-CODE	EAN	
anthracite	12,5×115×0,6 12,5×77×20,6	TDMCGANT	3 1 67890 013286	5



Ideal for planters from size 40 cm
Convient parfaitement pour les pots à partir de 40 cm
 Passend für Töpfe ab 40 cm





Combinable: simply click together with the attachment clip included or stagger them inside the pot

Fixation simple avec le clip de jonction

Kombinierbar: Einfach mit beigefügtem Verbindungsclip zusammenklicken oder versetzt im Topf anordnen

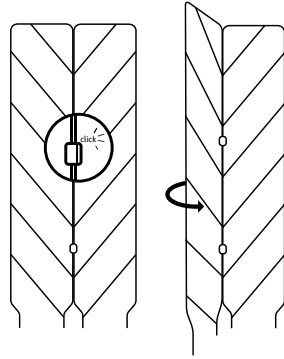

ATTACHMENT CLIP

CLIP DE JONCTION / VERBINDUNGSCLIP

COLOUR	CONTENT	L×W×H	C-CODE	EAN	
 anthracite	4 pcs.	19×8×1,2	4CJTANT	3 1 67890 013279	10



PLANT CLIPS

AGRAFES POUR PLANTES / PFLANZENKLAMMER

COLOUR	CONTENT	L×W×H	C-CODE	EAN	
 anthracite	4 pcs.	29×8×2,7	4CPMCGANT	3 1 67890 013330	10
 pale green	4 pcs.	29×8×2,7	4CPMCGVE	3 1 67890 013347	10



PLANT TIES

LIENS POUR PLANTES / PFLANZSCHLAUFE

COLOUR	CONTENT	L×W×H	C-CODE	EAN	
 anthracite	6 pcs.	20×7×1	6LPMCGANT	3 1 67890 013316	10
 pale green	6 pcs.	20×7×1	6LPMCGVE	3 1 67890 013323	10



PLANT ROD

TUTEUR / PFLANZSTAB



COLOUR	L×W×H	C-CODE	EAN	
 anthracite	9×153×0,6	TU153ANT	3 1 67890 013309	5



Ideal for planters from size 40 cm
Convient parfaitement pour les pots à partir de 40 cm
Passend für Töpfe ab 40 cm

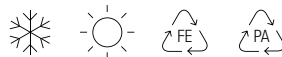

Good stability due to fork foot

Pied en fourche pour une bonne stabilité

Sicherer Stand durch Gabelfuß



03 BASIC MY CITY GARDEN

ROUND PLANTER

POT ROND / BLUMENKÜBEL RUND



COLOUR	Ø×H	••• L	C-CODE	EAN	
 granite	19,8×16	2,5	PMCGSC20GRA	3 1 6 7 8 9 0 1 0 1 3 3 9 2	10
 terracotta	19,8×16	2,5	PMCGSC20TC	3 1 6 7 8 9 0 1 0 1 3 4 1 5	10
 white	19,8×16	2,5	PMCGSC20BL	3 1 6 7 8 9 0 1 0 1 3 4 3 9	10
 green	19,8×16	2,5	PMCGSC20AN	3 1 6 7 8 9 0 1 0 1 3 4 5 3	10



Includes clip-on tray
Avec soucoupe clipsée
Inkl. angeclipstem Untersetzer

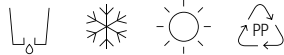

OVAL PLANTER

JARDINIÈRE / BLUMENKÜBEL OVAL



COLOUR	Ø×H	••• L	C-CODE	EAN	
 granite	39,6×19,5×16	7	JMCGSC40GRA	3 1 6 7 8 9 0 1 0 1 3 3 8 5	5
 terracotta	39,6×19,5×16	7	JMCGSC40TC	3 1 6 7 8 9 0 1 0 1 3 4 0 8	5
 white	39,6×19,5×16	7	JMCGSC40BL	3 1 6 7 8 9 0 1 0 1 3 4 4 6	5
 green	39,6×19,5×16	7	JMCGSC40AN	3 1 6 7 8 9 0 1 0 1 3 4 6 0	5

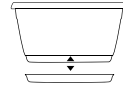

Includes clip-on tray
Avec soucoupe clipsée
Inkl. angeclipstem Untersetzer



WALL TRELLIS SET

LOT DE TREILLAGE MURAL / WANDGARTEN-RACK-SET



COLOUR	L×W×H	C-CODE	EAN	
 anthracite	110×36×1,5	ENSTMANT	3 1 6 7 8 9 0 1 0 1 3 4 2 2	5

Includes 4 wall brackets, screws & dowels
Avec 4 supports muraux, vis et chevilles
Inkl. 4 Wandhalterungen, Schrauben & Dübel

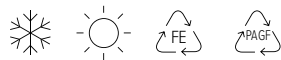

ACCESSORY HOOKS

CROCHETS POUR ACCESSOIRES / ZUBEHÖRHAKEN



COLOUR	CONTENT	L×W×H	C-CODE	EAN	
 aluminium	3 pcs.	20×7×1	3CRO6AL	3 1 6 7 8 9 0 1 0 1 3 5 0 7	10

max. 6 cm

18/10
STEEEL

PLANT POT HOOKS

CROCHETS POUR POT / TOPFHAKEN

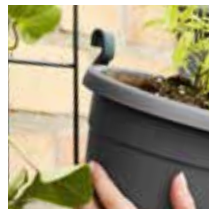

COLOUR	CONTENT	L×W×H	C-CODE	EAN	
 anthracite	4 pcs.	19×8×1,9	4CROPANT	3 1 6 7 8 9 0 1 0 1 3 3 5 4	10

Matching hook for the planter.
20 cm planter = 1 pot hook, 40 cm planter = 2 pot hooks
Le crochet assorti au bac.
Pot diam 20 cm = 1 crochet / Jardinière 40 cm = 2 crochets
Der passende Haken zum Blumenkübel.
20er Kübel = 1 Haken, 40er Kübel = 2 Haken



SPECIAL FENCE HOOKS

CROCHETS POUR POTS SPÉCIAL CLÔTURE / TOPFHAKEN



COLOUR	CONTENT	L×W×H	C-CODE	EAN	
 anthracite	4 pcs.	19×8×1,9	4CROPLOANT	3 1 6 7 8 9 0 1 0 1 3 4 9 1	20

Perfect for double stick mat fences.
20 cm planter = 1 pot hook, 40 cm planter = 2 pot hooks
Idéal pour la suspension sur clôture.
Pot diam 20 cm = 1 crochet / Jardinière 40 cm = 2 crochets
Ideal für Doppelstab-Mattenzäune.
20er Kübel = 1 Haken, 40er Kübel = 2 Haken





A clever assortment of pots, trellises and fastening systems!

Un assortiment de pots, treillages et systèmes de fixation malin !

Eine clevere Auswahl an modernen Pflanzgefäßen, Rankhilfen und Befestigungen.



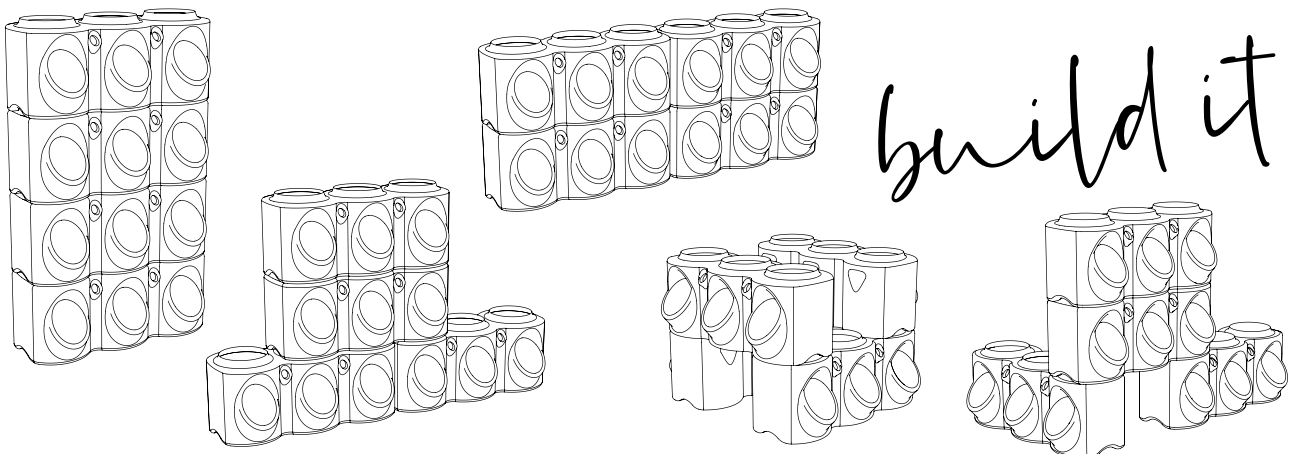



Aromabrik can be adapted to any space, even the smallest. It allows you to grow up to 9 aromatic plants! Designed as a system of bricks to be assembled, everyone will be able to build their own plant wall.

L'Aromabrik s'adapte à tous les espaces, même les plus petits. Il permet de faire pousser jusqu'à 9 plantes aromatiques ! Conçu comme un système de briques à assembler, chacun pourra construire son propre mur végétal.

Aromabrik kann an jeden noch so kleinen Raum angepasst werden und ermöglicht die Bepflanzung von bis zu 9 aromatischen Pflanzen! Dank des Baustein-Systems kann sich jeder seine eigene Pflanzwand bauen.



SET OF 2 BRICKS

LOT DE 2 BRIQUES / SET MIT ZWEI ELEMENTEN

COLOUR	L×W×H	❖ L	C-CODE	EAN	📦
● granite	63×30×52	2 x 30	ENSARONV	3 167890 000293	4
● taupe	63×30×52	2 x 30	ENSAROTA	3 167890 000286	4







PLANTER SMALL

JARDINIÈRE / BLUMENKÜBEL



COLOUR	L×W×H	✿ L	C-CODE	EAN	
 granite	62×22×20	14	JSCALA60NV	 3 167897 631216	3
 taupe	62×22×20	14	JSCALA60TA	 3 167897 531219	3



PLANTER BIG

BAC RECTANGULAIRE / BLUMENKÜBEL



COLOUR	L×W×H	✿ L	C-CODE	EAN	
 granite	75×37×38	65	BSCALA75NV	 3 167897 331215	3
 taupe	75×37×38	65	BSCALA75TA	 3 167897 231218	3



PLANTER SYSTEM

ENSEMBLE JARDINIÈRE ET BAC / BLUMENKÜBEL-SYSTEM



COLOUR	L×W×H	✿ L	C-CODE	EAN	
 granite	75×37×85	14 65	ENSSCALANV	 3 167897 931217	3
 taupe	75×37×85	14 65	ENSSCALATA	 3 167897 831210	3



Scala

SCALA is designed to dress-up your outdoor spaces quickly and easily. The two planters can be mounted one atop the other thanks to a self-blocking system in the legs, no tools required.

SCALA est conçu pour aménager très facilement et rapidement son extérieur. Les deux bacs s'installent l'un au-dessus de l'autre sans aucun outil, grâce à un système autobloquant des pieds.

Mit SCALA dekorieren Sie einfach und schnell Ihren Balkon, Terrasse oder Garten. Die beiden Blumenkästen lassen sich einfach ohne Werkzeug mit einer selbstblockierenden Verankerung übereinander montieren.



ROUND PLANTER

POT ROND / BLUMENKÜBEL RUND

COLOUR	Ø×H	L	C-CODE	EAN	
granite	18,3×13	2	PF18ANT	3 167897 231041	12
	24×16,5	4,5	PF25ANT	3 167897 431045	12
	31×21	10	PF30ANT	3 167897 531042	12
	35,2×23,7	14	PF35ANT	3 167897 631049	12
	40×27,5	21	PF40ANT	3 167897 731046	6
	47,5×33	36	PF50ANT	3 167897 931040	6
terracotta	18,3×13	2	PF18TC	3 167892 930062	12
	24×16,5	4,5	PF25TC	3 167892 930093	12
	31×21	10	PF30TC	3 167892 930109	12
	35,2×23,7	14	PF35TC	3 167892 930116	12
	40×27,5	21	PF40TC	3 167892 930123	6
	47,5×33	36	PF50TC	3 167892 930147	6
taupe	18,3×13	2	PF18TA	3 167890 831156	12
	24×16,5	4,5	PF25TA	3 167891 031159	12
	31×21	10	PF30TA	3 167891 131156	12
	35,2×23,7	14	PF35TA	3 167891 231153	12
	40×27,5	21	PF40TA	3 167891 331150	6
	47,5×33	36	PF50TA	3 167891 431157	6
62,1×41,8	79	PF60TA	3 167891 531154	6	

Ø×H	C-CODE	EAN	
17,2×2,4	SPRO25NV	3 167894 1131085	8
20,5×3	SPRO30NV	3 167894 231082	8
28×4	SPRO40NV	3 167894 431086	5
30×4,5	SPRO45NV	3 167896 000804	5
34,5×5	SPRO50NV	3 167894 531083	5
40,7×6	SPRO60NV	3 167896 831125	5
54×8	SPRO80NV	3 167894 131184	4
17,2×2,4	SPRO25TC	3 167894 731124	8
20,5×3	SPRO30TC	3 167894 931128	8
28×4	SPRO40TC	3 167895 1331125	5
30×4,5	SPRO45TC	3 167896 000859	5
34,5×5	SPRO50TC	3 167895 531129	5
40,7×6	SPRO60TC	3 167895 731123	5
54×8	SPRO80TC	3 167894 831183	4
17,2×2,4	SPRO25TA	3 167895 731086	8
20,5×3	SPRO30TA	3 167895 831083	8
28×4	SPRO40TA	3 167896 031086	5
30×4,5	SPRO45TA	3 167896 000811	5
34,5×5	SPRO50TA	3 167896 131083	5
40,7×6	SPRO60TA	3 167896 931122	5
54×8	SPRO80TA	3 167894 231181	4



Wide base for good stability
 Base large pour une bonne stabilité
 Stabiler Stand durch breiten Boden



100%
recycled 

03 BASIC FLORIO 





A functional and timeless range.
Designed for indoor and outdoor plants.





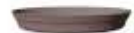











*Une gamme fonctionnelle et intemporelle.
Conçue pour l'intérieur et l'extérieur.*

*Funktionelle und zeitlose Serie.
Geeignet für innen und außen.*



ROUND PLANTER

POT ROND / BLUMENKÜBEL RUND

COLOUR	Ø×H	••• L	C-CODE	EAN	
 black	24,9×21,5	7	PCO25N	 3 167890 000064	6
	32,3×27,5	15	PCO32N	 3 167890 000088	6
	39,4×33,9	27	PCO40N	 3 167890 000101	6
	49,3×42,3	54	PCO50N	 3 167890 000125	6
 taupe	24,9×21,5	7	PCO25TA	 3 167890 000057	6
	32,3×27,5	15	PCO32TA	 3 167890 000071	6
	39,4×33,9	27	PCO40TA	 3 167890 000095	6
	49,3×42,3	54	PCO50TA	 3 167890 000118	6
 corten	24,9×21,5	7	PCO25COR	 3 167890 000941	6
	32,3×27,5	15	PCO32COR	 3 167890 000958	6
	39,4×33,9	27	PCO40COR	 3 167890 000965	6
	49,3×42,3	54	PCO50COR	 3 167890 000972	6







Ø×H	C-CODE	EAN	
20,5×3	SPCO25N	 3 167890 001115	6
27,8×4	SPCO32N	 3 167890 001146	6
34×5	SPCO40N	 3 167890 001177	6
41×6	SPCO50N	 3 167890 001207	6
20,5×3	SPCO25TA	 3 167890 001122	6
27,8×4	SPCO32TA	 3 167890 001153	6
34×5	SPCO40TA	 3 167890 001184	6
41×6	SPCO50TA	 3 167890 001214	6
20,5×3	SPCO25COR	 3 167890 001139	6
27,8×4	SPCO32COR	 3 167890 001160	6
34×5	SPCO40COR	 3 167890 001191	6
41×6	SPCO50COR	 3 167890 001221	6





RECTANGULAR PLANTER

BAC RECTANGULAIRE / PFLANZTROG

COLOUR	L×W×H	❁ L	C-CODE	EAN	🪴
 black	73,9×34,9×40,2	69	BRCOH70N	 3 167890 000187	5
 taupe	73,9×34,9×40,2	69	BRCOH70TA	 3 167890 000170	5
 corten	73,9×34,9×40,2	69	BRCOH70COR	 3 167890 001009	5

L×W×H	C-CODE	EAN	🪴
67×28×4,6	SBRCO70N	 3 167890 001269	5
67×28×4,6	SBRCO70TA	 3 167890 001276	5
67×28×4,6	SBRCO70COR	 3 167890 001283	5







Large planting volume
Grand volume de plantation
Großes Pflanzvolumen









COLUMN ROUND

POT ROND HAUT / SÄULE RUND

COLOUR	Ø×H	•••L	C-CODE	EAN	
 black	42,2 × 55,2	52	PCOH42N	 3 167890 000149	5
 taupe	42,2 × 55,2	52	PCOH42TA	 3 167890 000132	5
 corten	42,2 × 55,2	52	PCOH42COR	 3 167890 000989	5









Ø×H	C-CODE	EAN	
34 × 5	SPCO40N	 3 167890 001177	6
34 × 5	SPCO40TA	 3 167890 001184	6
34 × 5	SPCO40COR	 3 167890 001191	6



COLUMN SQUARE

BAC CARRÉ HAUT / SÄULE ECKIG

COLOUR	L×W×H	•••L	C-CODE	EAN	
 black	39,8 × 39,8 × 55,2	57	BCOH39N	 3 167890 000163	5
 taupe	39,8 × 39,8 × 55,2	57	BCOH39TA	 3 167890 000156	5
 corten	39,8 × 39,8 × 55,2	57	BCOH39COR	 3 167890 000996	5



L×W×H	C-CODE	EAN	
33,5 × 33,5 × 4,7	SBCO39N	 3 167890 001238	5
33,5 × 33,5 × 4,7	SBCO39TA	 3 167890 001245	5
33,5 × 33,5 × 4,7	SBCO39COR	 3 167890 001252	5



03 BASIC TERRA GRANDE

Terra grande





SQUARE PLANTER

BAC CARRÉ / BLUMENKÜBEL ECKIG



COLOUR	L×W×H	••• L	C-CODE	EAN	
 terracotta	29,5×29,5×24,5	11	BTG30TC		10
	35×35×28,5	19	BTG35TC		10
	39×39×31,5	27	BTG40TC		10
	49×49×38,5	50	BTG50TC		10
	59×59×44,5	95	BTG60TC		5
 anthracite	29,5×29,5×24,5	11	BTG30ANT		10
	35×35×28,5	19	BTG35ANT		10
	39×39×31,5	27	BTG40ANT		10
	49×49×38,5	50	BTG50ANT		10
	59×59×44,5	95	BTG60ANT		5

L×W×H	C-CODE	EAN	
25,1×25,1×3,9	SBTG25TC		10
30×30×4,8	SBTG29TC		10
36×36×5,5	SBTG36TC		10
–	–	–	–
–	–	–	–
25,1×25,1×3,9	SBTG25ANT		10
30×30×4,8	SBTG29ANT		10
36×36×5,5	SBTG36ANT		10
–	–	–	–
–	–	–	–

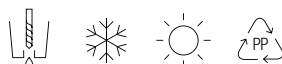

RECTANGULAR PLANTER

BAC RECTANGULAIRE / PFLANZTROG



COLOUR	L×W×H	••• L	C-CODE	EAN	
 terracotta	59×29×27	29	JTG60TC		10
	79×34×28,5	43	JTG80TC		10
 anthracite	59×29×27	29	JTG60ANT		10
	79×34×28,5	43	JTG80ANT		10

L×W×H	C-CODE	EAN	
56,7×27,3×4,5	SJTG5727TC		10
–	–	–	–
56,7×27,3×4,5	SJTG5727ANT		10
–	–	–	–

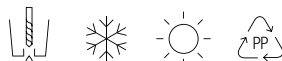

lotus

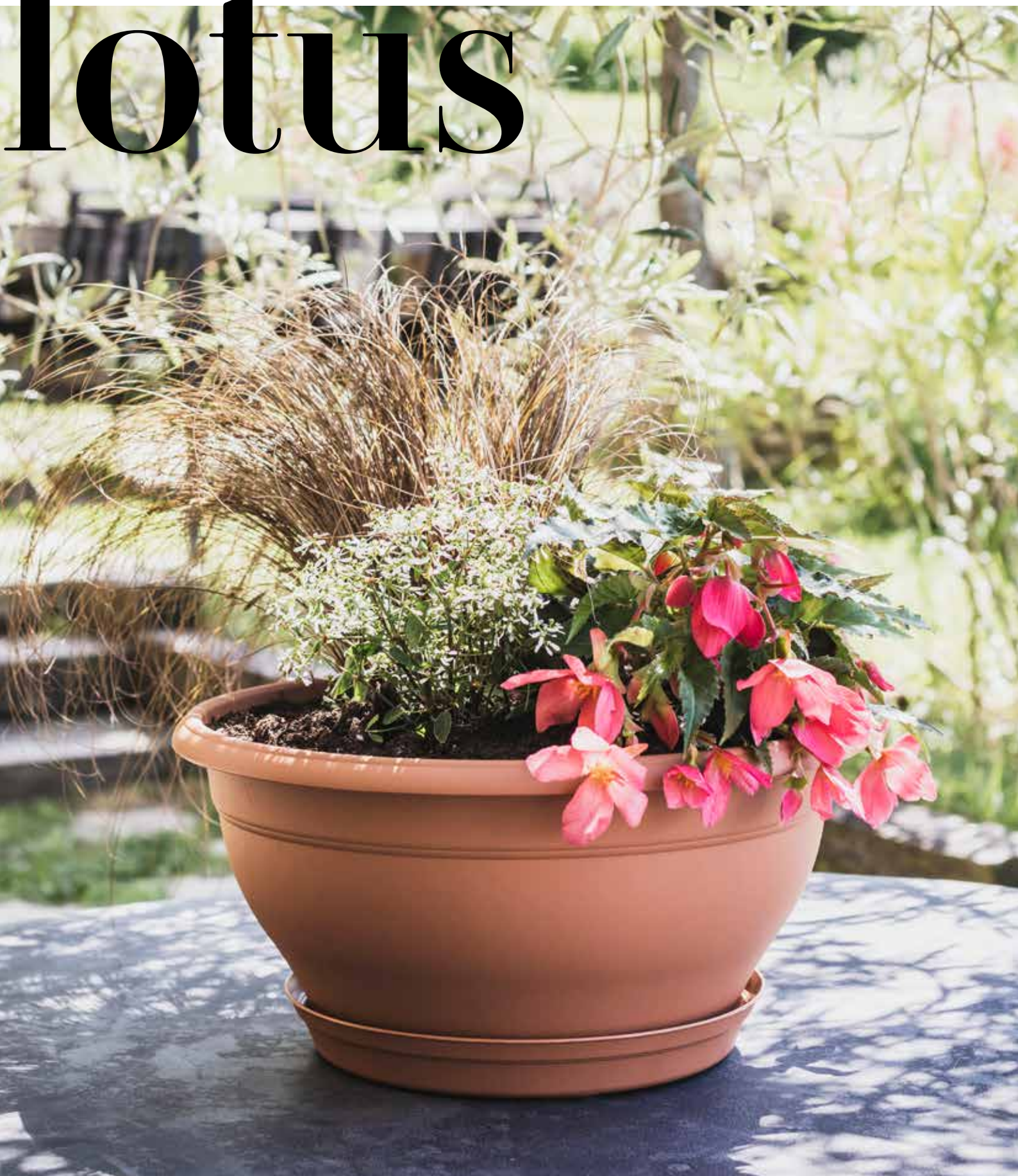



ROUND CUP PLANTER

COUPE / BLUMENKÜBEL RUND

COLOUR	Ø×H	••L	C-CODE	EAN	
granite	25,4×12,5	3	CLS25NV	3 167892 530972	10
	30,5×15	5,3	CLS30NV	3 167892 630979	10
	35,6×17,5	8,4	CLS35NV	3 167894 729718	10
	40,7×20	13	CLS40NV	3 167899 330995	6
taupe	25,4×12,5	3	CLS25TA	3 167892 931144	10
	30,5×15	5,3	CLS30TA	3 167893 031140	10
	35,6×17,5	8,4	CLS35TA	3 167893 131147	10
	40,7×20	13	CLS40TA	3 167893 231144	6
red morello	25,4×12,5	3	CLS25GT	3 167890 931207	10
	30,5×15	5,3	CLS30GT	3 167891 031203	10
terracotta	25,4×12,5	3	CLS25TC	3 167892 929684	10
	30,5×15	5,3	CLS30TC	3 167892 929691	10
	35,6×17,5	8,4	CLS35TC	3 167892 929714	10
	40,7×20	13	CLS40TC	3 167892 929721	6



Includes clip-on tray
Avec soucoupe clipsée
Inkl. angeclipstem Untersetzer



SUSPENSION HOOKS

CROCHET SUSPENSION / HAKEN ZUM AUFHÄNGEN

COLOUR	L×W×H	C-CODE	EAN	
granite	52 x 7 x 1	CROLSNV	3 167893 130973	15
taupe	52 x 7 x 1	CROSLSTA	3 167893 331141	15
red morello	52 x 7 x 1	CROSLSGT	3 167891 131200	15
terracotta	52 x 7 x 1	CROSLSTC	3 167892 930390	15

Changes planter into hanging pot
Pour convertir la coupe en suspension
Verwandelt Topf in Blumenampel

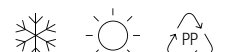

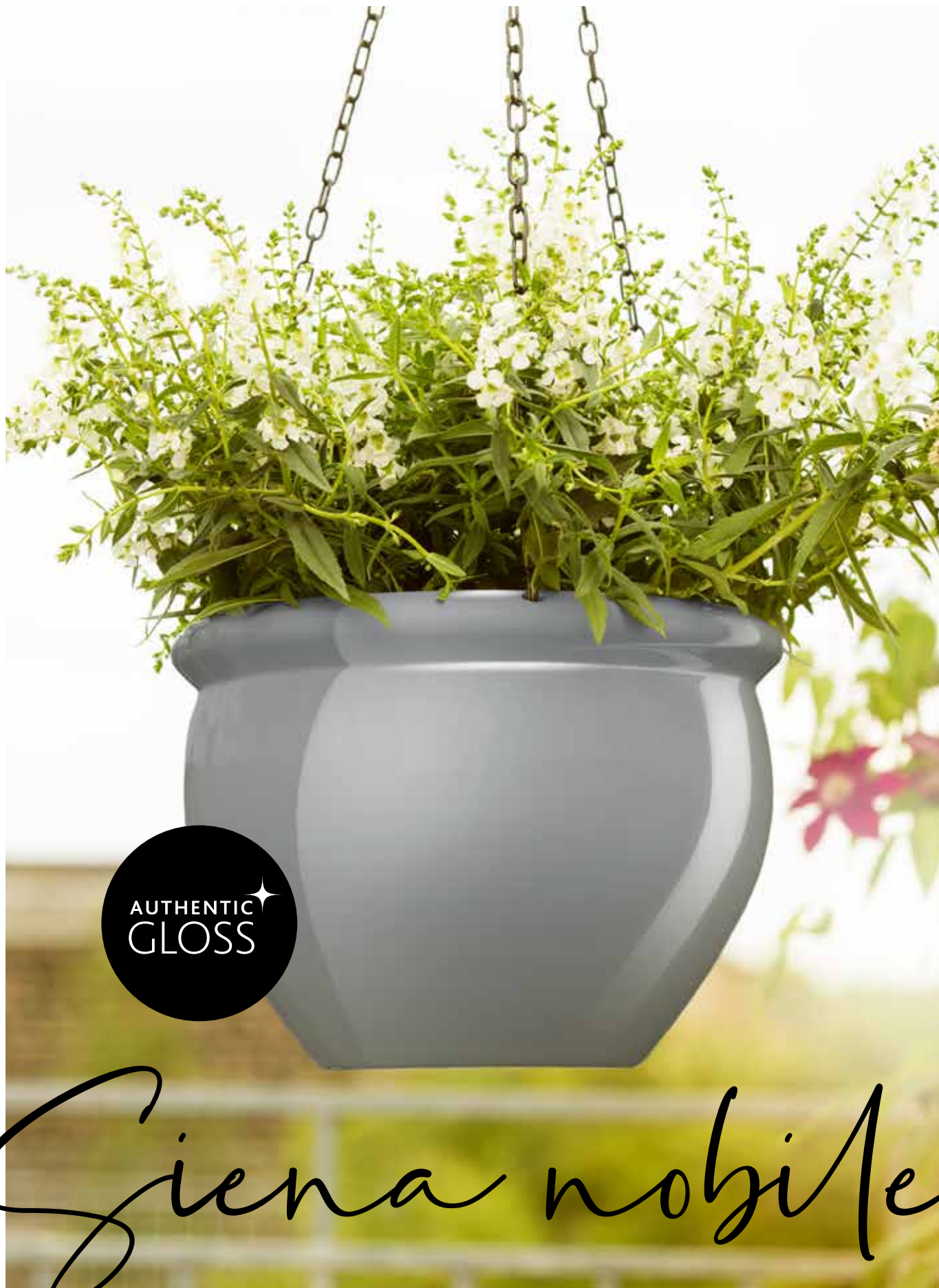

















AUTHENTIC
GLOSS

Sienna nobile



ROUND CUP PLANTER









COUPE / BLUMENKÜBEL RUND

COLOUR	Ø×H	••• L	C-CODE	EAN	
 pearl white	26,5×19,5	5,5	CSN26BL	 3 1 6 7 8 9 0 0 1 5 6 4 8	3
	32×23,5	11	CSN32BL	 3 1 6 7 8 9 0 0 1 5 6 5 5	3
	38×29	22	CSN38BL	 3 1 6 7 8 9 0 0 1 5 6 6 2	3
 dusty grey	26,5×19,5	5,5	CSN26GC	 3 1 6 7 8 9 0 0 1 5 6 7 9	3
	32×23,5	11	CSN32GC	 3 1 6 7 8 9 0 0 1 5 6 8 6	3
	38×29	22	CSN38GC	 3 1 6 7 8 9 0 0 1 5 6 9 3	3
 anthracite	26,5×19,5	5,5	CSN26ANT	 3 1 6 7 8 9 0 0 1 5 7 0 9	3
	32×23,5	11	CSN32ANT	 3 1 6 7 8 9 0 0 1 5 7 1 6	3
	38×29	22	CSN38ANT	 3 1 6 7 8 9 0 0 1 5 7 2 3	3
 ruby	26,5×19,5	5,5	CSN26RU	 3 1 6 7 8 9 0 0 1 5 7 6 1	3
	32×23,5	11	CSN32RU	 3 1 6 7 8 9 0 0 1 5 7 7 8	3
	38×29	22	CSN38RU	 3 1 6 7 8 9 0 0 1 5 7 8 5	3

HANGING PLANTER

SUSPENSION / HÄNGESCHALE



COLOUR	Ø×H	••• L	C-CODE	EAN	
 pearl white	26×19,5	5,5	SSN26BL	 3 1 6 7 8 9 0 0 1 5 5 9 4	3
 dusty grey	26×19,5	5,5	SSN26GC	 3 1 6 7 8 9 0 0 1 5 6 0 0	3
 anthracite	26×19,5	5,5	SSN26ANT	 3 1 6 7 8 9 0 0 1 5 6 1 7	3
 ruby	26×19,5	5,5	SSN26RU	 3 1 6 7 8 9 0 0 1 5 6 3 1	3





Including hanging chain
Avec chaîne de suspension
Inklusive Hängekette



aquarelle

WINDOW BOX JARDINIÈRE / BLUMENKASTEN



COLOUR	L×W×H	☼ L	💧 L	C-CODE	EAN	
 granite	49×21×16,9	8	2	JAQ50NV	3 1 67891 931220	8
 taupe	49×21×16,9	8	2	JAQ50TA	3 1 67892 031226	8







with
support

WINDOW BOX + SUPPORT

JARDINIÈRE AVEC SUPPORT / BLUMENKASTEN MIT KASTENHALTER



COLOUR	L×W×H	☼ L	💧 L	C-CODE	EAN	
 granite	49×21×19	8	2	LJAQ50NVSUP	3 1 67891 531208	15
 taupe	49×21×19	8	2	LJAQ50TASUP	3 1 67891 631205	15
 red morello	49×21×19	8	2	LJAQ50GTSUP	3 1 67891 831209	15
 terracotta	49×21×19	8	2	LJAQ50TCSUP	3 1 67891 731202	15

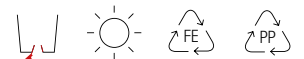

Equipped with a water reserve grid and an overflow system

Equipée d'une grille à réserve d'eau et d'un bouchon trop plein refermable

Mit Wasserspeicher und Überlaufsystem



100% recycled 



Odélia

WINDOW BOX
JARDINIÈRE / BLUMENKASTEN



COLOUR	L×W×H	•••L	C-CODE	EAN	
 granite	48,5×20×16	11	ODE50ANT	3 167899 631177	16
 taupe	48,5×20×16	11	ODE50TA	3 167899 731174	16

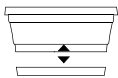



Includes clip-on tray
Avec soucoupe clipsée
Inkl. angeclipstem Untersetzer



WINDOW BOX + SUPPORT

JARDINIÈRE AVEC SUPPORT / BLUMENKASTEN MIT KASTENHALTER

COLOUR	L×W×H	•••L	C-CODE	EAN	
 granite	49×27×19,5	11	ODE50SUPANT	3 167899 831171	19
 taupe	49×27×19,5	11	ODE50SUPTA	3 167899 931178	19



Includes clip-on tray
Avec soucoupe clipsée
Inkl. angeclipstem Untersetzer

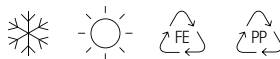

with
support









WINDOW BOX

JARDINIÈRE / BLUMENKASTEN



COLOUR	L×W×H	••• L L	C-CODE	EAN	
 terracotta	50×22×18	10 2,1	JLA50TC	3 167890 015891	5
	75×22×18	16 3,3	JLA75TC	3 167890 015907	5
	100×22×18	21 4,6	JLA100TC	3 167890 015914	5
 white	50×22×18	10 2,1	JLA50BL	3 167890 015921	5
	75×22×18	16 3,3	JLA75BL	3 167890 015938	5
	100×22×18	21 4,6	JLA100BL	3 167890 015945	5
 smoky brown	50×22×18	10 2,1	JLA50MK	3 167890 015952	5
	75×22×18	16 3,3	JLA75MK	3 167890 015969	5
	100×22×18	21 4,6	JLA100MK	3 167890 015976	5
 graphite	50×22×18	10 2,1	JLA50ANT	3 167890 015983	5
	75×22×18	16 3,3	JLA75ANT	3 167890 015990	5
	100×22×18	21 4,6	JLA100ANT	3 167890 016003	5



VARIO Comfort

The perfect bracket for every box
Supports adaptés à chaque jardinière
 Für jeden Kasten die passende Halterung
P./ S. 139

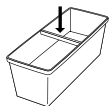

75 + 100 cm
 With reinforcement rod
Avec traverse de renfort
 Mit Verstärkungsstrebe



Lago



Generous planting volume and
 integrated watering-system

*Grand volume de plantation, réserve
 d'eau et indicateur de niveau d'eau*

*Großes Pflanzvolumen und
 integriertes Bewässerungssystem*



From decorative accessories to practical watering cans for the garden... Poétic offers a wide range of watering cans and sprayers to take care of all plants and meet all consumer needs.

De l'accessoire déco à l'arrosoir pratique pour le jardin ... Poétic propose une large gamme d'arrosoirs et de vaporisateurs pour prendre soin des plantes et répondre à tous les usages consommateurs.

Von dekorativen Accessoires bis hin zu praktischen Gießkannen... Poétic bietet eine große Auswahl an Gießkannen und Sprühern, um der Pflege aller Pflanzen und der Bedürfnisse aller Konsumenten gerecht zu werden.



o bloom & grow watering





hana

Timeless design, clear lines. HANA stands for stylish and functional watering. Placed in a visible position, it becomes a discreetly reduced interior design piece. More than just a watering can.

Design intemporel, lignes droites épurées. Placé bien en vue, il devient un objet de décoration intérieure à part entière. Bien plus qu'un arrosoir.

Zeitloses Design, klare Linien. HANA steht für stilvolle und funktionale Bewässerung. Sichtbar platziert, wird sie zu einem dezent-reduzierten Interior-Stück. Mehr als nur ein Gießer.



New
product



Long-lasting brass nozzle
Buse en laiton robuste et réglable
Langlebige Messingdüse

WATERING SPRAYER

VAPORISATEUR / BLUMENSPRÜHER



COLOUR	L×W×H	L	C-CODE	EAN	
steel	7,7×7,7×19,2	0,7	VHA0L7IN	3 1 6 7 8 9 0 1 0 4 2 3 0 9	4
white	7,7×7,7×19,2	0,7	VHA0L7BL	3 1 6 7 8 9 0 1 0 4 2 3 1 6	4
black	7,7×7,7×19,2	0,7	VHA0L7N	3 1 6 7 8 9 0 1 0 4 2 3 2 3	4

Made with stainless steel
Acier inoxydable
Aus Edelstahl

18/10
STEEL

WATERING CAN

ARROSOIR / BLUMENGIESSER



COLOUR	L×W×H	L	C-CODE	EAN	
steel	28×12×21	1,6	AHA1L6IN	3 1 6 7 8 9 0 1 0 1 7 3 8 3	4
white	28×12×21	1,6	AHA1L6BL	3 1 6 7 8 9 0 1 0 1 7 4 0 6	4
black	28×12×21	1,6	AHA1L6N	3 1 6 7 8 9 0 1 0 1 7 3 9 0	4

Made with stainless steel
Acier inoxydable
Aus Edelstahl

18/10
STEEL



Lowered filling opening for easy
and drip-free filling.

*Ouverture renfoncée pour un
remplissage simple et sans goutte.*

*Abgesenkte Einfüllöffnung für beson-
ders leichtes und tropffreies Befüllen.*



loft glossy

Soft Touch: feels good and protects sensitive surfaces.







Soft Touch : agréable au toucher – préserve les surfaces délicates.

Soft Touch: fühlt sich gut an – schont empfindliche Oberflächen.



WATERING CAN

ARROSOIR / BLUMENGIESSER

COLOUR	L×W×H	L	C-CODE	EAN	
 green	32×14×17	1,8	ALO1L8V	3 167890 016737	4
 white	32×14×17	1,8	ALO1L8BL	3 167890 016744	4
 dusty grey	32×14×17	1,8	ALO1L8GC	3 167890 016751	4
 silk grey	32×14×17	1,8	ALO1L8GS	3 167890 016799	4
 sepia rose	32×14×17	1,8	ALO1L8RS	3 167890 016812	4
 sage	32×14×17	1,8	ALO1L8SA	3 167890 016836	4



SPRAYER

VAPORISATEUR / BLUMENSPRÜHER

COLOUR	L×W×H	L	C-CODE	EAN	
 green	12,8×9,8×25,4	0,7	VLO0L7V	3 167890 016768	4
 white	12,8×9,8×25,4	0,7	VLO0L7BL	3 167890 016775	4
 dusty grey	12,8×9,8×25,4	0,7	VLO0L7GC	3 167890 016782	4
 silk grey	12,8×9,8×25,4	0,7	VLO0L7GS	3 167890 016805	4
 sepia rose	12,8×9,8×25,4	0,7	VLO0L7RS	3 167890 016829	4
 sage	12,8×9,8×25,4	0,7	VLO0L7SA	3 167890 016843	4



Long-lasting brass nozzle
Buse en laiton robuste et réglable
Langlebige Messingdüse



**WATERING CAN**

ARROSOIR / BLUMENGIESSER

COLOUR	L×W×H	L	C-CODE	EAN	
 transparent	32 × 14 × 17	1,8	ALOFU1L8INC	3 1 67890 017529	4
 smoke	32 × 14 × 17	1,8	ALOFU1L8G	3 1 67890 017536	4
 smoky green	32 × 14 × 17	1,8	ALOFU1L8VS	3 1 67890 017543	4
 sepia brown	32 × 14 × 17	1,8	ALOFU1L8MK	3 1 67890 017550	4



loft smoked

Living design with smoked glass – the new trend material.

Finition transparente – imitation verre fumé ultra tendance.

Wohndesign mit Rauchglas – das neue Trendmaterial.

**SPRAYER**

VAPORISATEUR / BLUMENSPRÜHER

COLOUR	L×W×H	L	C-CODE	EAN	
 transparent	12,8 × 9,8 × 25,4	0,7	VLOFU0L7INC	3 1 67890 017567	4
 smoke	12,8 × 9,8 × 25,4	0,7	VLOFU0L7G	3 1 67890 017574	4
 smoky green	12,8 × 9,8 × 25,4	0,7	VLOFU0L7VS	3 1 67890 017581	4
 sepia brown	12,8 × 9,8 × 25,4	0,7	VLOFU0L7MK	3 1 67890 017598	4



Long-lasting brass nozzle
Buse en laiton robuste et réglable
Langlebige Messingdüse



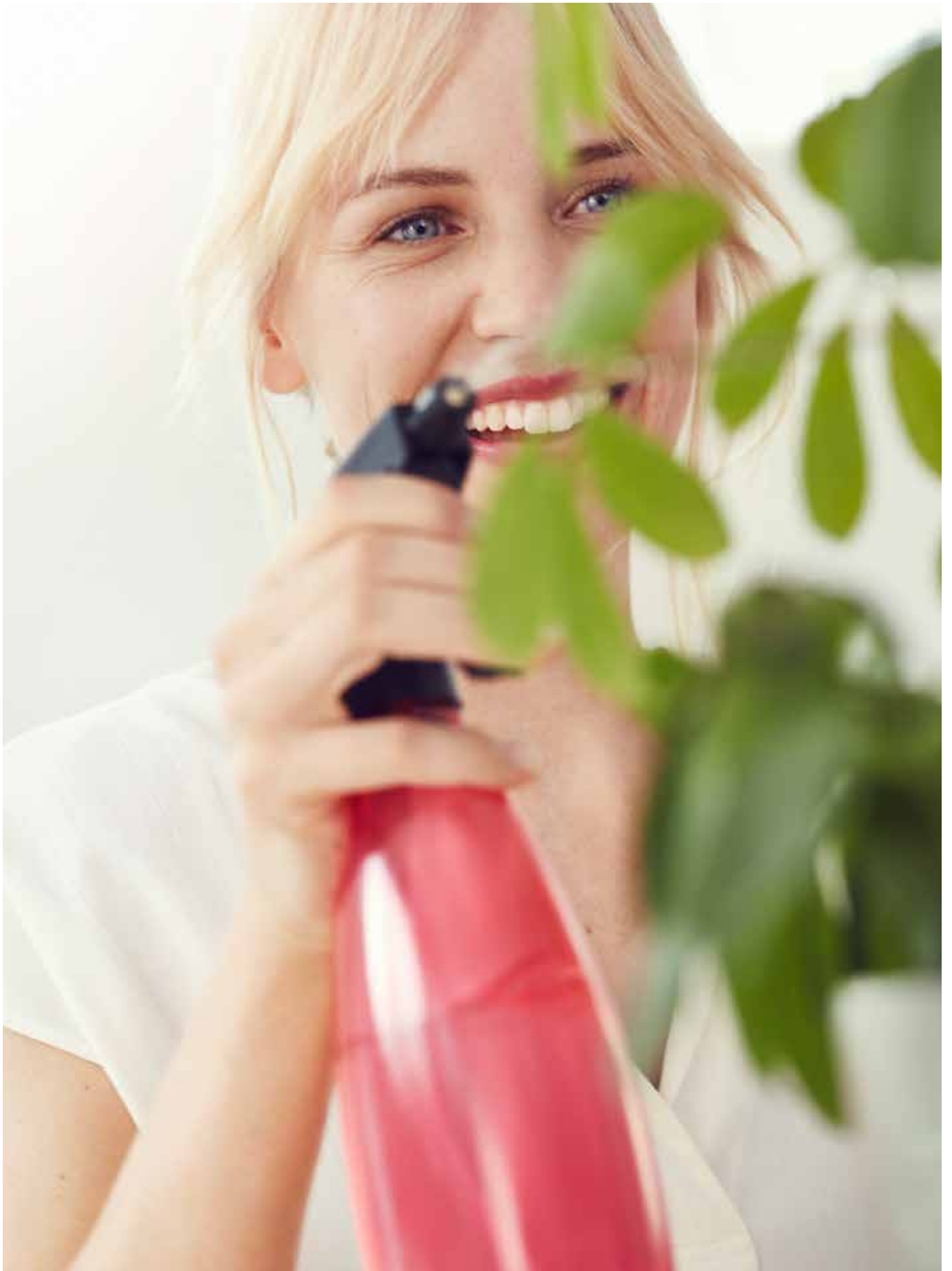



fuchsia

transparent

WATERING CAN

ARROSOIR / BLUMENGIESSER



COLOUR	L×W×H	L	C-CODE	EAN	
transp.	32×11,5×17	1,5	AFUTR1L5INC	3 1 6 7 8 9 0 0 1 6 3 2 4	4
transp. sun yellow	32×11,5×17	1,5	AFUTR1L5J	3 1 6 7 8 9 0 0 1 6 3 8 6	4
transp. raspberry red	32×11,5×17	1,5	AFUTR1L5FR	3 1 6 7 8 9 0 0 1 6 4 0 9	4
transp. melon red	32×11,5×17	1,5	AFUTR1L5PA	3 1 6 7 8 9 0 0 1 6 4 2 3	4
transp. lime green	32×11,5×17	1,5	AFUTR1L5CV	3 1 6 7 8 9 0 0 1 6 4 4 7	4
transp. topaz blue	32×11,5×17	1,5	AFUTR1L5B	3 1 6 7 8 9 0 0 1 6 3 3 1	4



SPRAYER

VAPORISATEUR / BLUMENSPRÜHER



COLOUR	L×W×H	L	C-CODE	EAN	
transp.	11×7,5×25,5	0,7	VFUTROL7INC	3 1 6 7 8 9 0 0 1 6 3 4 8	4
transp. sun yellow	11×7,5×25,5	0,7	VFUTROL7J	3 1 6 7 8 9 0 0 1 6 3 9 3	4
transp. raspberry red	11×7,5×25,5	0,7	VFUTROL7FR	3 1 6 7 8 9 0 0 1 6 4 1 6	4
transp. melon red	11×7,5×25,5	0,7	VFUTROL7PA	3 1 6 7 8 9 0 0 1 6 4 3 0	4
transp. lime green	11×7,5×25,5	0,7	VFUTROL7CV	3 1 6 7 8 9 0 0 1 6 4 5 4	4
transp. topaz blue	11×7,5×25,5	0,7	VFUTROL7B	3 1 6 7 8 9 0 0 1 6 3 5 5	4



Long-lasting brass nozzle
Buse en laiton robuste et réglable
Langlebige Messingdüse



1/4 DISPLAY EQUIPPED

1/4 PRÉSENTOIR GARNI / 1/4 DISPLAY BESTÜCKT

L×W×H	C-CODE	EAN	
60×40×160	BOX890	3 1 6 7 8 9 0 0 0 3 2 1 8	1

40× Watering can / Arrosoir / Gießber

4
 8
 4
 8
 8
 8

28× Sprayer / Vaporisateur / Sprüher

4
 4
 4
 4
 8



WATERING CAN

ARROSOIR / BLUMENGIESSER

COLOUR	L×W×H	L	C-CODE	EAN	
transparent	32×11,5×17	1,5	AFUTR1L5INC	3 167890 016324	4
amber	32×11,5×17	1,5	AFUFU1L5AM	3 167890 016461	4
bottle green	32×11,5×17	1,5	AFUFU1L5VB	3 167890 016478	4
smoke	32×11,5×17	1,5	AFUFU1L5G	3 167890 016485	4
smoky green	32×11,5×17	1,5	AFUFU1L5VS	3 167890 016690	4
sepia brown	32×11,5×17	1,5	AFUFU1L5MK	3 167890 016713	4



fuchsia smoked

SPRAYER

VAPORISATEUR / BLUMENSPRÜHER



COLOUR	L×W×H	L	C-CODE	EAN	
transparent	11×7,5×25,5	0,7	VFUTR0L7INC	3 167890 016348	4
amber	11×7,5×25,5	0,7	VFUFU0L7AM	3 167890 016492	4
bottle green	11×7,5×25,5	0,7	VFUFU0L7VB	3 167890 016508	4
smoke	11×7,5×25,5	0,7	VFUFU0L7G	3 167890 016515	4
smoky green	11×7,5×25,5	0,7	VFUFU0L7VS	3 167890 016706	4
sepia brown	11×7,5×25,5	0,7	VFUFU0L7MK	3 167890 016720	4



Long-lasting brass nozzle
Buse en laiton robuste et réglable
Langlebige Messingdüse



1/4 DISPLAY EQUIPPED

1/4 PRÉSENTOIR GARNI / 1/4 DISPLAY BESTÜCKT

L×W×H	C-CODE	EAN	
60×40×160	BOX891	3 167890 003225	1

40× Watering can / Arrosoir / Gießler

8 4 4 8 8 8

28× Sprayer / Vaporisateur / Sprüher

8 4 4 4 4 4





fuchsia

opaque

WATERING CAN

ARROSOIR / BLUMENGIESSER





COLOUR	L×W×H	L	C-CODE	EAN	
 turquoise	32×11,5×17	1,5	AFUOP1L5TU	3 1 6 7 8 9 0 1 0 1 6 5 4 6	4
 green	32×11,5×17	1,5	AFUOP1L5AN	3 1 6 7 8 9 0 1 0 1 6 5 6 0	4
 light pink	32×11,5×17	1,5	AFUOP1L5RO	3 1 6 7 8 9 0 1 0 1 6 5 7 7	4



SPRAYER

VAPORISATEUR / BLUMENSPRÜHER



COLOUR	L×W×H	L	C-CODE	EAN	
 turquoise	11×7,5×25,5	0,7	VFUOP0L7TU	3 1 6 7 8 9 0 1 0 1 6 5 8 4	4
 green	11×7,5×25,5	0,7	VFUOP0L7AN	3 1 6 7 8 9 0 1 0 1 6 5 9 1	4
 light pink	11×7,5×25,5	0,7	VFUOP0L7RO	3 1 6 7 8 9 0 1 0 1 6 5 5 3	4







Long-lasting brass nozzle
Buse en laiton robuste et réglable
Langlebige Messingdüse



WATERING CAN

ARROSOIR / BLUMENGIESSER







COLOUR	L×W×H	L	C-CODE	EAN	
 white	32×11,5×17	1,5	AFUOP1L5BL	3 1 6 7 8 9 0 1 0 1 6 6 5 2	4
 creme	32×11,5×17	1,5	AFUOP1L5CR	3 1 6 7 8 9 0 1 0 1 6 6 6 9	4
 silk grey	32×11,5×17	1,5	AFUOP1L5GS	3 1 6 7 8 9 0 1 0 1 6 6 7 6	4
 anthracite	32×11,5×17	1,5	AFUOP1L5ANT	3 1 6 7 8 9 0 1 0 1 6 6 8 3	4



SPRAYER

VAPORISATEUR / BLUMENSPRÜHER



COLOUR	L×W×H	L	C-CODE	EAN	
 white	11×7,5×25,5	0,7	VFUOP0L7BL	3 1 6 7 8 9 0 1 0 1 6 6 1 4	4
 creme	11×7,5×25,5	0,7	VFUOP0L7CR	3 1 6 7 8 9 0 1 0 1 6 6 2 1	4
 silk grey	11×7,5×25,5	0,7	VFUOP0L7GS	3 1 6 7 8 9 0 1 0 1 6 6 3 8	4
 anthracite	11×7,5×25,5	0,7	VFUOP0L7ANT	3 1 6 7 8 9 0 1 0 1 6 6 4 5	4



Long-lasting brass nozzle
Buse en laiton robuste et réglable
Langlebige Messingdüse



Oase



WATERING CAN
ARROSOIR / BLUMENGIESSER

COLOUR	L×W×H	L	C-CODE	EAN	
white	30×13,5×21,5	1,5	AOA1L5BL	3 167890 016850	6
	38×16×25	3	AOA3BL	3 167890 016867	4
	44×17,5×29	5	AOA5BL	3 167890 016874	4
granite	30×13,5×21,5	1,5	AOA1L5GRA	3 167890 016881	6
	38×16×25	3	AOA3GRA	3 167890 016898	4
	44×17,5×29	5	AOA5GRA	3 167890 016904	4
silk grey	30×13,5×21,5	1,5	AOA1L5GS	3 167890 016911	6
	38×16×25	3	AOA3GS	3 167890 016928	4
	44×17,5×29	5	AOA5GS	3 167890 016935	4
green	30×13,5×21,5	1,5	AOA1L5V	3 167890 016942	6
	38×16×25	3	AOA3V	3 167890 016959	4
	44×17,5×29	5	AOA5V	3 167890 016966	4
antique blue	30×13,5×21,5	1,5	AOA1L5BLP	3 167890 016973	6
	38×16×25	3	AOA3BLP	3 167890 016980	4
	44×17,5×29	5	AOA5BLP	3 167890 016997	4

1,5 – 5,0 L
Beautiful & robust – Large volume
Esthétique & robuste – Grand volume
Schön & robust – Großes Volumen



SPRAYER
VAPORISATEUR / BLUMENSPRÜHER

L×W×H	L	C-CODE	EAN	
10,5×11,5×26,5	1	VOA1BL	3 167890 017000	6
10,5×11,5×26,5	1	VOA1GRA	3 167890 017017	6
10,5×11,5×26,5	1	VOA1GS	3 167890 017024	6
10,5×11,5×26,5	1	VOA1V	3 167890 017031	6
10,5×11,5×26,5	1	VOA1BLP	3 167890 017048	6



Long-lasting brass nozzle
Buse en laiton robuste et réglable
Langlebige Messingdüse









100%
recycled* 

04 FLOWER CARE EMMA 



WATERING CAN

ARROSOIR / BLUMENGIESSER

COLOUR	L×W×H	L	C-CODE	EAN	
 taupe	52 × 14 × 26,5	2,5	AEMMA2L5TA	3 167899 031175	8
  blue jean	52 × 14 × 26,5	2,5	AEMMA2L5BJ	3 167890 039484	8
  sunflower	52 × 14 × 26,5	2,5	AEMMA2L5TO	3 167890 039507	8



emma

DISPLAY EQUIPPED

PRÉSENTOIR GARNI / DISPLAY BESTÜCKT

L×W×H	C-CODE	EAN	
78,5 × 58,5 × 145	BOX920	3 167890 042569	1









48 × Watering Can / Arrosoir / Blumengießler

 16  16  16

SPRAYER

VAPORISATEUR / BLUMENSPRÜHER



COLOUR	L×W×H	L	C-CODE	EAN	
 taupe	14 × 14 × 26	1	VEMMA1TA	3 167898 731175	8
  blue jean	14 × 14 × 26	1	VEMMA1BJ	3 167890 039477	8
  sunflower	14 × 14 × 26	1	VEMMA1TO	3 167890 039491	8



DISPLAY EQUIPPED

PRÉSENTOIR GARNI / DISPLAY BESTÜCKT

L×W×H	C-CODE	EAN	
38 × 38 × 77	BOX921	3 167890 042576	1



39 × Sprayer / Vaporisateur / Blumensprüher

 13  13  13





* Only blue jean and sunflower



STRENGTHENED WATERING CAN

ARROSOIR RENFORCÉ / BLUMENGIESSER VERSTÄRKT

COLOUR	L×W×H	L	C-CODE	EAN	
 green	48×22×45	12	ALYON12L	 3 167890 003850	8



WATERING CAN
ARROSOIR / BLUMENGIESSER



COLOUR	L×W×H	L	C-CODE	EAN	
green	45×13×30	4	AJ4	3 167890 003836	12
	47×17×38	6	AJ6	3 167890 328281	12
	50×18×37	11	AJ11P	3 167890 328298	10
taupe	47×17×38	6	AJ6TA	3 167890 931184	12
blue jean	47×17×38	6	AJ6BJ	3 167890 042545	12
sunflower	47×17×38	6	AJ6TO	3 167890 042552	12
black	47×17×38	6	AJ6N	3 167890 000316	12

New colour

New colour

Watering head included
Pomme d'arrosage incluse
Inklusive Sprinklerkopf



STRENGTHENED WATERING CAN

ARROSOIR RENFORCÉ /
BLUMENGIESSER VERSTÄRKT



COLOUR	L×W×H	L	C-CODE	EAN	
blue jean	59×20×40	12	AJ12R	3 167890 028792	8
green	59×20×40	12	AEXF12L	3 167890 003843	8

Watering head included – blue with POMMETAL,
green with POMMEGM (see table below)
Pomme d'arrosage incluse – bleu avec POMMETAL,
vert avec POMMEGM (voir le tableau ci-dessous)
Inklusive Sprinklerkopf – blau mit POMMETAL,
grün mit POMMEGM (siehe Tabelle unten)



ROSE FOR WATERING CAN

POMMES / SPRINKLERKÖPFE

COLOUR	Ø	C-CODE	EAN	
black	10,5	POMME6	3 167890 028419	20
black	13	POMMEGM	3 167890 028426	20
black	12,5	POMMETAL	3 167890 028808	5



SPRAYING BOOM

RAMPE D'ARROSAGE / RASENSPRINKLER

COLOUR	L×W×H	C-CODE	EAN	
red	52×4×15	RP	3 167890 004109	10



* only blue jean, sunflower and green AJ11P





practical accessories

Discover a wide range of accessories, practical for gardening work.
The complete range of metal supports offers a solution for all situations.







*Découvrez un large choix d'accessoires, pratiques pour les travaux
de jardinage. La gamme complète de supports métalliques offre quant
à elle, une solution adaptée à toutes les situations.*

*Entdecken Sie eine breite Palette an praktischem Zubehör für die
Gartenarbeit. Das komplette Sortiment an Metallstützen bietet für jede
Situation die perfekte Lösung.*



TRANSPARENT BUCKET

GODET A FLEURS, TRANSLUCIDE / TRANSPARENTER PFLANZTOPF

COLOUR	Ø×H	C-CODE	EAN	
 transparent	12×9	GF12TR		20
	14×11	GF14TR		20
	16×12	GF16TR		15
	18×13,5	GF18TR		10

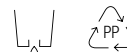

TRANSPARENT BUCKET SPECIAL ORCHIDS

GODET TRANSLUCIDE, SPÉCIAL ORCHIDÉES / PFLANZTOPF, SPEZIELL FÜR ORCHIDEEN

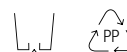

COLOUR	Ø×H	C-CODE	EAN	
 transparent	13×11,4	GORCH13TR		22
	15×13,1	GORCH15TR		23
	17×14,9	GORCH17TR		20





TRANSPARENT SAUCER ROUND

SOUCOUPE RONDE TRANSPARENTE / TRANSPARENTER RUNDER UNTERSETZER

COLOUR	Ø×H	C-CODE	EAN	
 transparent	11,5×1,6	STR12	 3 1 6 7 8 9 0 0 0 1 0 1 6	10
	14,5×2,1	STR15	 3 1 6 7 8 9 0 0 0 1 0 3 0	10
	17,2×2,4	STR17	 3 1 6 7 8 9 0 0 0 1 0 4 7	10
	20,5×2,8	STR21	 3 1 6 7 8 9 0 0 0 1 0 6 1	10
	27,8×3,8	STR28	 3 1 6 7 8 9 0 0 0 1 0 7 8	10
	34×4,7	STR34	 3 1 6 7 8 9 0 0 0 1 0 8 5	10



TRANSPARENT SAUCER SQUARE







SOUCOUPE CARRÉE TRANSPARENTE / TRANSPARENTER ECKIGER UNTERSETZER

COLOUR	L×W×H	C-CODE	EAN	
 transparent	20×20×3	SC18T	 3 1 6 7 8 9 7 8 3 0 9 5 4	20
	27×27×3,2	SC25T	 3 1 6 7 8 9 7 9 3 0 9 5 1	10
	34×34×3,6	SC32T	 3 1 6 7 8 9 8 0 3 0 9 5 7	10
	45×45×4	SC43T	 3 1 6 7 8 9 8 3 3 0 9 6 5	5



STANDARD SAUCER

SOUCOUPE STANDARD / STANDARD UNTERSETZER

COLOUR	L×W×H	C-CODE	EAN	
 terracotta	41×19×3	SBG40TC	 3 1 6 7 8 9 0 1 2 3 3 2 9	10
	51×19×3	SBG50TC	 3 1 6 7 8 9 0 1 2 3 3 3 6	10
	61×19×3	SBG60TC	 3 1 6 7 8 9 0 1 2 3 3 4 3	10
	81×19×3	SBG80TC	 3 1 6 7 8 9 0 1 2 3 3 5 0	5



05 ACCESSORIES GARDEN CONTAINERS



GARDEN CONTAINERS

CONTAINERS POUR LE JARDIN / EIMER FÜR GARTENABFÄLLE

COLOUR	Ø×H	● L	C-CODE	EAN	🪴	Ø×H	● L	C-CODE	EAN	🪴
● black	16,7×13	2	CONT2L	3 660611 005244	30	37,7×26	20	CONT20L	3 660611 005114	15
	19×15	3	CONT3L	3 660611 005336	24	42,9×29,8	30	CONT30L	3 660611 005138	15
	22,5×18	5	CONT5L	3 660611 005459	23	50,5×35	43	CONT43L	8 006417 002448	5
	28×22	10	CONT10L	3 660611 005527	18	54×41	65	CONT65L	8 006417 002455	5
	33×26	15	CONT15L	3 660611 005107	15	66×48	110	CONT110L	8 006417 004121	1



**FLY SWATTER**

TAPETTE À MOUCHES / FLIEGENKLATSCHER



COLOUR	L×W×H	C-CODE	EAN	
mixed	47×10×1	TAP	3 1 67890 020055	50

**WASP TRAP**

PIÈGE À GUÊPES / WESPENFALLE



COLOUR	L×W×H	C-CODE	EAN	
transparent	18,5×18×15	PG	3 1 67890 020000	10

**DISPLAY EQUIPPED**

PRÉSENTOIR GARNI / DISPLAY BESTÜCKT

L×W×H	C-CODE	EAN	
80×60×145	BOX6	3 1 67890 022066	1

60 x Wasp Trap / 60 x Pièges à guêpes / 60 x Wespenfalle

**GROWING BELL**

CLOCHE À SALADE ET CLOCHE À BLANCHIR / SALATGLOCKE UND ANZUCHTHAUBE

COLOUR	Ø×H	C-CODE	EAN	
transparent	26×17,5	CS26	3 660611 009839	24
black	26×17,5	CS26N	3 660611 009822	24
transparent	33×26	CS33	3 660611 014895	12
transparent	43×29,5	CT43	3 660611 009846	10





supports



VARIO COMFORT

METAL BRACKETS / SUPPORTS / BLUMENKASTENHALTER

COLOUR	C-CODE	EAN	
white	SUPJVACBL	3 167890 017086	10
aluminium	SUPJVACAL	3 167890 017093	10
anthracite	SUPJVACANT	3 167890 017109	10

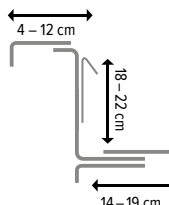
**50 kg**

Suitable for:
Compatible avec:
U.a. passend für:
**CASA MESH, LANDHAUS,
MY CITY GARDEN, COUNTRY, LAGO**

1. Universal use / Usage universel / Universell einsetzbar
2. Easy handling / Manipulation facile / Einfache Handhabung
3. For round and square railings / Pour balustrades rondes et carrées / Für runde und eckige Geländer
4. Convenient graduated lock-in position / Pratique : position de verrouillage gradué / Komfortable Stufenrastung



SPECIAL

METAL BRACKETS / SUPPORTS / BLUMENKASTENHALTER

COLOUR	C-CODE	EAN	
white	SUPJCMEMCGBL	3 167890 017055	10
aluminium	SUPJCMEMCGAL	3 167890 017062	10
anthracite	SUPJCMEMCGANT	3 167890 017079	10

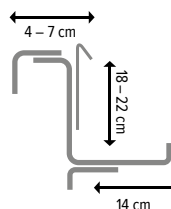
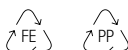
**50 kg**

Suitable for:
Compatible avec:
Passend für:
**CASA MESH & MY CITY GARDEN
WINDOW BOXES**

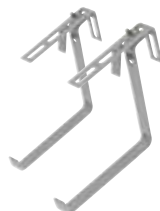

LANDHAUS

METAL BRACKETS / SUPPORTS / BLUMENKASTENHALTER

COLOUR	C-CODE	EAN	
white	SUPJLHBL	3 167890 014870	10
aluminium	SUPJLHAL	3 167890 014887	10

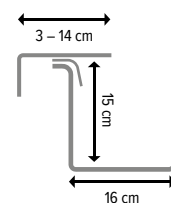
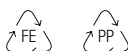
**25 kg**

Suitable for:
Compatible avec:
Passend für:
**LANDHAUS WINDOW BOXES
50, 75, 100 CM**



VARIO UNIVERSAL

METAL BRACKETS / SUPPORTS / BLUMENKASTENHALTER

COLOUR	C-CODE	EAN	
white	SUPJVAUNBL	3 1 67890 017116	10
aluminium	SUPJVAUNAL	3 1 67890 017123	10
terracotta	SUPJVAUNTC	3 1 67890 017130	10
smoky brown	SUPJVAUNMK	3 1 67890 017147	10
anthracite	SUPJVAUNANT	3 1 67890 017154	10

50 kg



Ideal for large or heavy boxes
Idéal pour les jardinières grand format ou lourdes
Ideal für große oder schwere Kästen

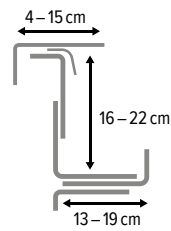

BASIC

METAL BRACKETS / SUPPORTS / BLUMENKASTENHALTER

COLOUR	C-CODE	EAN	
white	SUPJVABABL	3 1 67890 017161	10
aluminium	SUPJVABAAL	3 1 67890 017178	10
anthracite	SUPJVABAANT	3 1 67890 017185	10

25 kg



Ideal for small or medium-sized boxes
Idéal pour des jardinières de petit et moyen format
Ideal für kleine oder mittlere Kästen

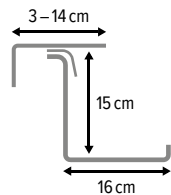



SPECIAL FOR RAILINGS

METAL BRACKETS / SUPPORTS POUR BALUSTRADE ARRONDIE /
BLUMENKASTENHALTER FÜR RUNDGELÄNDER

COLOUR	C-CODE	EAN	
white	SUPJBALBL	3 1 67890 017192	10
aluminium	SUPJBALAL	3 1 67890 017208	10
anthracite	SUPJBALANT	3 1 67890 017215	10

25 kg



Suitable for standard railings up to 4.5 cm
Pour les balustrades rondes d'un diamètre max. de 4,5 cm
Für Standard-Rundgeländer bis 4,5 cm geeignet

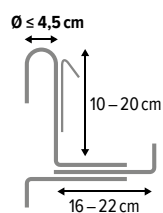

SPECIAL FOR WALLS

METAL BRACKETS / SUPPORTS POUR MURS /
BLUMENKASTENHALTER FÜR MAUERN

COLOUR	C-CODE	EAN	
white	SUPJMBL	3 1 67890 017222	10
aluminium	SUPJMAL	3 1 67890 017239	10
anthracite	SUPJMANT	3 1 67890 017246	10

50 kg



Ideal for walls
Idéal pour murs
Ideal für Mauern

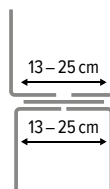





WAVE

METAL BRACKETS / SUPPORTS / BLUMENKASTENHALTER



COLOUR	L×W×H	C-CODE	EAN	
 anthracite	47×31,5×22	FF309777	3 167897 730971	6
	57×31,5×22	FF309778	3 167897 830978	6
	67×32×22	FF309901	3 167890 130990	6

 15 kg



Powder coated steel
Peinture époxy
Pulverbeschichteter Stahl



STANDARD SUPPORT

METAL BRACKETS / SUPPORTS STANDARDS / BLUMENKASTENHALTER



COLOUR	L×W×H	C-CODE	EAN	
 anthracite	37×29×21	FF309775	3 167897 530977	12
	48×27×21	FF310595	3 167899 531057	12
	39×26×21	FF309776	3 167897 630974	12
 white	37×29×21	STD3716BL	3 167891 931213	12
	39×26×21	STD3921BL	3 167892 031219	12

 15–17 kg

With safety bar. Powder coated steel
Avec barre de sécurité. Peinture époxy
Mit Sicherheitsleiste. Pulverbeschichteter Stahl





ADJUSTABLE SECURITY SUPPORT

SUPPORT RÉGLABLE SÉCURITÉ / VERSTELLBARE BLUMENKASTENHALTERUNG

COLOUR	L×W×H	C-CODE	EAN	
 anthracite	37×29×27	FF309779	 3 1 67897 930975	6
	53×32×21	SUPP53X22GM	 3 1 67896 531180	6

15 kg

Powder coated steel and hammered effect

Peinture époxy et effet martelé

Pulverbeschichteter Stahl und Hammerschlageffekt



UNIVERSAL BRACKET

PATTE DE FIXATION UNIVERSELLE RÉGLABLE / BLUMENKASTENHALTER UNIVERSAL

COLOUR	L×W×H	C-CODE	EAN	
 anthracite	36×2×25,5	FF310596	 3 1 67899 631054	6

12 kg

Universal adjustable. Powder coated steel

Universel-Ajustable. Peinture époxy

Universell verstellbar und aus pulverbeschichtetem Stahl

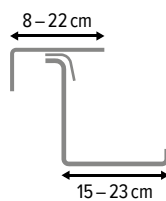



POT SUPPORT FOR BALCONY

SUPPORTS POT BALCON / BLUMENTOPFHALTERUNG FÜR BALKON



COLOUR	Ø×H	C-CODE	EAN	
 anthracite	18×17	FF309780	3 167898 030971	12
	23×20	FF309781	3 167898 130978	12
 white	18×17	SUPBAL18BL	3 167892 131216	12
	23×20	SUPBAL23BL	3 167892 231213	12

5–7 kg

Powder coated steel
Peinture époxy
Pulverbeschichteter Stahl



POT SUPPORT FOR FACADE

SUPPORTS POT FAÇADE / BLUMENTOPFHALTERUNG FÜR FASSADEN



COLOUR	Ø×H	C-CODE	EAN	
 anthracite	18×19,5	FF309782	3 167898 230975	12
	23×24	FF309783	3 167898 330972	12

5–7 kg

Powder coated steel
Peinture époxy
Pulverbeschichteter Stahl



METAL BRACKETS

POTENCES MÉTAL / WANDHALTER FÜR BLUMENAMPEL

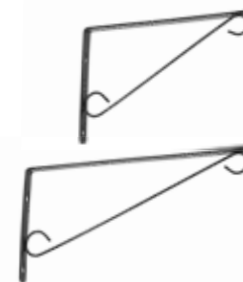

COLOUR	L×W×H	C-CODE	EAN	
 anthracite	30,5×2×20,5	FF309785	3 167898 530976	6
	40×2×20,5	FF309996	3 167899 630996	6

7 kg

Powder coated steel
Peinture époxy
Pulverbeschichteter Stahl





WHEEL SUPPORTS ROUND

SUPPORT À ROULETTES ROND / ROLLUNTERSETZER RUND



COLOUR	Ø×H	C-CODE	EAN	
 anthracite	29,5×6,5	NEP4RRD	 3 167899 331176	6

40 kg

Powder coated steel
Peinture époxy
Pulverbeschichteter Stahl



WHEEL SUPPORTS SQUARE

SUPPORT À ROULETTES CARRÉ / ROLLUNTERSETZER ECKIG



COLOUR	L×W×H	C-CODE	EAN	
 anthracite	30×30×6,5	NEP4RCA	 3 167899 431173	6

40 kg

Powder coated steel
Peinture époxy
Pulverbeschichteter Stahl



05 ACCESSORIES SPARE PARTS



CASA PLANTERS & CUBES 30 CM

WATER LEVEL INDICATOR / INDICATEUR DE NIVEAU D'EAU / WASSERSTANDSANZEIGER



CM	C-CODE	EAN	
34	SP000596	3 167890 035097	6



FILLING CHAMBER / ENTONNOIR DE REMPLISSAGE / FÜLLSCHACHT

CM	C-CODE	EAN	
26	SP000595	3 167890 035080	6



DRAINAGE PLATE / PLAQUE DE DRAINAGE / DRAINAGEPLATTE

CM	C-CODE	EAN	
25×25×6	SP000597	3 167890 035103	6



PLANTING TRAY / INSERT DE PLANTATION / PFLANZEINSATZ

CM	C-CODE	EAN	
30×30×28	SP000598	3 167890 035110	1



SCREWS / VIS / SCHRAUBEN

CONTENT	C-CODE	EAN	
2 pcs.	SP000599	3 167890 035127	6



CASA PLANTER ROUND 25 CM

WATERING SET / KIT D'ARROSAGE / BEWÄSSERUNGSKIT

CM	C-CODE	EAN	
21×6	SP000592	3 167890 035059	1

CASA PLANTER ROUND 30 CM

WATERING SET / KIT D'ARROSAGE / BEWÄSSERUNGSKIT

CM	C-CODE	EAN	
29×6	SP000593	3 167890 035066	1

CASA PLANTER ROUND 36 CM

WATERING SET / KIT D'ARROSAGE / BEWÄSSERUNGSKIT

CM	C-CODE	EAN	
36×6	SP000594	3 167890 035073	1

Drainage plate, Water level indicator, Special padding
 Plaque de drainage, Indicateur de niveau d'eau, Feutre spécial
 Drainageplatte, Wasserstandsanzeiger, Spezialvlies



CASA & MYCITY GARDEN RAILING POT 30 CM

DRAINAGE PLATE*** / PLAQUE DE DRAINAGE*** / DRAINAGEPLATTE***

CONTENT	C-CODE	EAN	
2 pcs.	SP000601	3 167890 035141	6

MY CITY GARDEN RAILING POT 60 CM

DRAINAGE PLATE*** / PLAQUE DE DRAINAGE*** / DRAINAGEPLATTE***

CONTENT	C-CODE	EAN	
2 pcs.	SP000602	3 167890 035158	6

CASA & MY CITY GARDEN RAILING POT

SCREWS WITH COVERS*** / VIS AVEC CACHES*** / SCHRAUBEN INKL. ABDECKUNG***

CONTENT	C-CODE	EAN	
2 pcs.	SP000603	3 167890 035165	6

**CASA MESH,
MY CITY GARDEN & LAGO**WATER LEVEL INDICATOR* / INDICATEUR DE NIVEAU D'EAU*
WASSERSTANDSANZEIGER*

CM	C-CODE	EAN	
22	SP000583	3 167890 034960	6

CASA, MY CITY GARDEN & LAGO

SPECIAL PADDING** / FEUTRE SPÉCIAL** / SPEZIALVLIES**



CM	C-CODE	EAN	
200	SP000582	3 167890 042521	6

CASA & MY CITY GARDEN

SPECIAL PADDING** / FEUTRE SPÉCIAL** / SPEZIALVLIES**

CONTENT	C-CODE	EAN	
3 pcs. à 47 cm	SP000589	3 167890 035028	6

CASA MESH & MY CITY GARDEN

FILLING CHAMBER* / ENTONNOIR* / FÜLLSCHACHT*



CM	C-CODE	EAN	
18	SP000590	3 167890 035035	6

CASA MESH & MY CITY GARDEN

REINFORCEMENT RODS* / TRAVERSE DE RENFORT* / VERSTÄRKUNGSSTREBEN*



CONTENT	C-CODE	EAN	
20 pcs.	SP000591	3 167890 035042	1

LAGO

REINFORCEMENT RODS* / TRAVERSES DE RENFORT* / VERSTÄRKUNGSSTREBEN*

CONTENT	C-CODE	EAN	
20 pcs.	SP000586	3 167890 034991	1

LAGO

FILLING CHAMBER* / ENTONNOIR* / FÜLLSCHACHT*

CM	C-CODE	EAN	
18	SP000587	3 167890 035004	6

6× 3×

FRESH HERBS

WATERING SET / KIT D'IRRIGATION / BEWÄSSERUNGSSET



CONTENT	C-CODE	EAN	
9 pcs.	KITIRFH	3 167890 035011	1

LOFT

SPRAY HEAD / TÊTE D'ARROSAGE / SPRÜHKOPF



COLOUR	C-CODE	EAN	
grey	SP000600	3 167890 035134	1

FUCHSIA & OASE

SPRAY HEAD / TÊTE D'ARROSAGE / SPRÜHKOPF



COLOUR	C-CODE	EAN	
black	SP000585	3 167890 034984	1

SIENA NOBILE

SPARE CHAIN / CHÂÎNE DE RECHANGE / ERSATZKETTE



C-CODE	EAN	
SP000584	3 167890 034977	1

* For window boxes / pour jardinières / für Blumenkästen

** For window boxes and planters with long-term watering system / pour jardinières et bacs à fleurs avec le système d'irrigation continue / für Blumenkästen und -kübel mit Langzeitbewässerungssystem

*** For railing pots / pour pot pour balustrade / für Geländertöpfe





POÉTIC 2022 **ESTERAS**



esteras™ 

ESTERAS. The beauty of authenticity. Benefit from our lifestyle brand for high-quality planters. Order our new catalogue.

ESTERAS. Une grande maîtrise artisanale, des matériaux de qualité et la recherche d'un design authentique. Découvrez notre large gamme de pots et bacs décoratifs. Demandez notre nouveau catalogue.

ESTERAS. Die Freude am Echten. Profitieren Sie von unserer Lifestyle-Marke für hochwertige Pflanzgefäße. Fordern Sie unseren neuen Katalog an.

www.esteras.com



POÉTIC 2022 COLOURS & PRODUCT DETAILS

colours

51

Colours to suit every style – from classic to modern.
 Couleurs pour tous les styles, du classique au moderne.
 Farben für jeden Stil – von klassisch bis modern.

 black noir schwarz	 graphite graphite graphite	 anthracite anthracite anthrazit	 slate ardoise schiefer	 granite granite granit	 steel acier stahl	 dusty grey gris cendre staubgrau	 concrete beton beton	 ash gris cendre aschgrau	 cement ciment zement
 white blanc weiss	 pearl white blanc perle perlweiss	 creme crème cremeweiss	 cotton coton baumwolle	 silk grey gris soie seidengrau	 limestone calcaire kalkstein	 taupe taupe taupe	 smoky brown brun fumé rauchbraun	 mud brun braun	 mocca moka mokka
 corten corten corten	 terracotta terre cuite terrakotta	 gala terracotta terracotta gala terrakotta	 red violet framboise rotviolett	 ruby rubis rubinrot	 red morello griotte sauerkirsche	 cherry cerise kirsche	 red rouge rot	 light pink rose claire hellpink	 sepia rose rose sépia sepia rosé
 turquoise turquoise türkisgrün	 antique blue bleu pale altblau	 blue jean bleu jean jeansblau	 laurel green vert laurier lorbeergrün	 khaki kaki khaki	 sage saugé salbei	 green vert dunkelgrün	 green anis grün	 yellow jaune gelb	 sunflower tournesol sonnenblume

Transparent

 transparent transparent transparent	 smoke fumé rauch	 sepia brown moka sepiabraun	 amber ambre bernstein	 sun yellow jaune sonnengelb	 melon red pastèque melone	 raspberry red framboise himbeere	 topaz blue bleu topasblau	 lime green citron vert limettengrün	 bottle green vert bouteille flaschengrün	 smoky green vert fumé rauchgrün
--	---	--	--	--	--	---	--	--	---	--

* For the range of CASA Sleeve, the colour range refers to the textile coating
 Pour la gamme CASA Sleeve, la couleur fait référence au revêtement textile / Für die Serie CASA Sleeve bezieht sich die Farbe auf den Textil-Mantel

product details



New product / Nouveauté / Neuheit



UV resistant / Résistant aux UV / UV-beständig



Holes to make / Pré percé / Bohrung möglich



Frost resistant / Résistant au gel / Frostfest



Screw stopper for drainage hole / Bouchon
 Verschlusschraube für den Ablauf



High quality steel / Acier de haute qualité
 Hochwertiger Stahl



100% leak-proof / 100% hermétique / 100% dicht



Material / Matière / Material



Rollers / Galets roulants / Rollen



Metal / Métal / Metall



Stopper with overflow / Bouchon avec trop plein
 Kappe mit Überlauf



get in contact

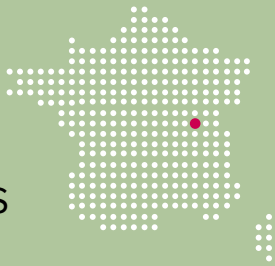

POÉTIC SAS

38 route de Louhans
71370 Saint Germain du Plain
Tel. +33 385 42 12 00
commercial@poetic-jardin.fr

01 FRANCE

Sylvain MAJEWSKI
Tel. +33 6 82 58 57 22
smajewski@poetic-jardin.fr

Dept.:
02, 08, 51, 59, 60,
62, 76, 80

Renaud SAPET
Tel. +33 6 82 58 57 17
rsapet@poetic-jardin.fr

Dept.:
04, 05, 06, 07, 13, 26,
30, 38, 73, 83, 84

Jean PERRETTA
Tel. +33 6 82 58 57 19
jperretta@poetic-jardin.fr

Dept.:
25, 52, 54, 55, 57,
67, 68, 70, 88, 90

Jérôme BOUTELIER
Tel. +33 6 82 58 57 21
jboutelier@poetic-jardin.fr

Dept.:
27, 28, 75, 78, 92, 94, 95

Lionel BOUTECHOQUE
Tel. +33 6 99 61 82 97
lboutechoque@poetic-jardin.fr

Dept.:
10, 45, 77, 89, 91, 93

Thierry RENAUD
Tel. +33 6 82 58 57 20
trenaud@poetic-jardin.fr

Dept.:
22, 29, 35, 44, 50, 56, 85

Nathalie CHARRETIER
Tel. +33 6 33 48 62 12
ncharretier@poetic-jardin.fr

Dept.:
14, 18, 36, 37, 41, 49, 53,
61, 72, 79, 86

Raphaël GUILLAUD-PIVOT
Tel. +33 6 82 58 57 18
rguillaudpivot@poetic-jardin.fr

Dept.:
01, 03, 21, 39, 42, 58,
63, 69, 71, 74

Audrey AUGER
Tel. +33 6 49 00 39 03
aauger@poetic-jardin.fr

Dept.:
12, 15, 16, 17, 19, 23, 24,
33, 43, 46, 48, 87

Romain JADEC
Tel. +33 6 82 58 57 16
rjadec@poetic-jardin.fr

Dept.:
09, 11, 31, 32, 34, 40, 47,
64, 65, 66, 81, 82

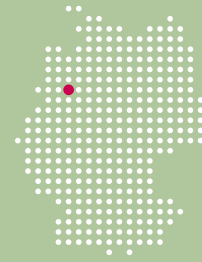

POÉTIC GmbH

Münsterstrasse 111
48155 Münster
Tel. +49 2506 3063 10
kundenservice@poetic-garden.com

02 GERMANY

Michael AHRENDT
Tel. +49 171 6 79 51 92
mahrendt@poetic-garden.com

Zip code:
10 – 13, 16 – 31

Frank HOCHBAUM
Tel. +49 160 5 53 69 51
fhochbaum@poetic-garden.com

Zip code:
01 – 06, 09, 14, 15,
34, 37 – 39, 99

Roland PICHLER
Tel. +49 152 29 99 48 92
rpichler@poetic-garden.com

Zip code:
07, 08, 80 – 87, 90 – 98

Daniel MENSING
Tel. +49 152 25 62 91 31
dmensing@poetic-garden.com

Zip code:
32, 33, 48, 49, 59

Michael BOSCH
Tel. +49 171 3 02 00 76
mbosch@poetic-garden.com

Zip code:
35, 36, 40 – 47, 50 – 53,
56 – 58, 60 – 63, 65

Christopher HÄRTER-BAUMGART
Tel. +49 171 5 73 10 38
chaerter@poetic-garden.com

Günter KRAUSKOPF
Tel. +49 178 1 85 76 03
gkrauskopf@poetic-garden.com

Zip code:
54, 55, 64, 66 – 79, 88, 89

AUSTRIA

Daniel ROHDE-AGARIUS
Tel. +43 664 3 86 25 12
drohdeagarius@poetic-garden.com

SWITZERLAND

Christopher HÄRTER-BAUMGART
Tel. +49 171 5 73 10 38
chaerter@poetic-garden.com

03 EXPORT

BALTICS / SCANDINAVIA / UK

Nils NYBORG MADSEN
Tel. +45 40 22 06 39
nmadsen@poetic-garden.com

BENELUX

Jean-Paul MATTERN
Tel. +32 478 235 193
mattern@skynet.be

SOUTHERN EUROPE / SOUTHERN AMERICA / AFRICA

Rémy FRANCISCO
Tel. +33 7 89 98 39 09
rfrancisco@poetic-jardin.fr

EASTERN EUROPE / MIDDLE & NORTH AMERICA

Uwe IKE
Tel. +49 171 3 79 73 46
uike@poetic-garden.com

MIDDLE EAST / ASIA PACIFICS

Martin LEUNG
Tel. +84 86 6 07 97 88
mleung@poetic-garden.com

Subject to technical alterations/error.
Printing colour deviations possible.
This catalogue is printed on FSC-certified paper.

*Sous réserve de modifications techniques.
Modifications des couleurs possibles lors de l'impression.
Ce catalogue est imprimé sur papier certifié FSC.*

*Technische Änderungen/Irrtum vorbehalten.
Drucktechnische Farbabweichungen möglich.
Dieser Katalog wurde auf FSC-zertifiziertem
Papier produziert.*

POÉTIC Garden Catalogue international 2022
NE003369

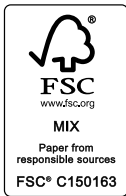

Poétic SAS

France

38 route de Louhans
71370 Saint Germain du Plain
Tel. +33 385 42 12 00
commercial@poetic-jardin.fr
www.poetic-jardin.fr

Poétic GmbH

Germany – Austria – Switzerland

Münsterstraße 111
48155 Münster
Tel. +49 2506 3063 10
kundenservice@poetic-garden.com
www.poetic-garden.com

Export Markets

Münsterstraße 111
48155 Münster
Tel. +49 2506 3063 10
kundenservice@poetic-garden.com
www.poetic-garden.com